

Product Range



Sleepers

Concrete retaining wall sleepers for small garden walls up to large civil works projects. Durable and easy to install.



Lonsdale



Blackwood



McLaren



Cove



Kensington



Ashwood



Elwood

AS3600/2009 Compliant

To comply with the recent Australian Standards all concrete sleepers are 50mpa. Concrete complies with AS3600/2009. All reinforcing bar is ACRS Compliant.

All retaining walls above 1m must have council approval and engineering.

SLEEPER SIZES

2.0m x 200mm x 75mm	Standard
2.0m x 200mm x 100mm	Heavy Duty
2.0m x 200mm x 120mm	Extra Heavy Duty
2.4m x 200mm x 80mm	Standard
2.4m x 200mm x 100mm	Heavy Duty
2.4m x 200mm x 130mm	Extra Heavy Duty
3.0m x 200mm x 110mm	Heavy Duty
3.0m x 200mm x 150mm	Extra Heavy Duty

Galvaised Sleeper Posts

100 UC, 100 PFC, 90 Deg Corner, 45 Deg Corner all in Galvanised material, in pre cut sizes starting at –

900, 1200, 1500, 1800, 2100, 2400, 2700 and 3000mm.

Custom and larger sizes available upon request.

TABLE OF CONTENTS

SECTION REFERENCE

BUILDING & HARDWARE	A	TOOLS	F
DOOR PRODUCTS	B	WATERING SYSTEMS	G
HB FULLER PRODUCTS	C	WHEELBARROWS	H
DRAINAGE & GRATINGS	D		
GARDEN PRODUCTS	E		

ALPHABETICAL LISTING

ITEM	SECTION	PG NO	ITEM	SECTION	PG NO
A					
ACCESS DOORS SUBFLOOR	B	14	AQUASOL	E	1
ACO DRAINS	D	1	ASSEMBLED FRAMES	B	2
ANNEALED WIRE	A	1	AXE	F	1
ANT CAP	A	1			
ANT, ROACH & SPIDER KILLERS	E	1			
B					
BAG OF RAGS	A	1	BLOOD AND BONE	E	1
BAG TIES	A	1	BOLSTERS	F	1
BAMBOO STAKES	E	1	BOLT CUTTERS	F	1
BARS	F	1	BONDCRETE	A	2
BAR CHAIRS	A	1	BONDRITE	A	2
BAR GUARD	A	15	BRICKWELD	A	2
BARRIER MESH	A	1	BROOM HANDLES	F	1
BARRIER TAPE	A	2	BROOMS	F	1
BITUMINOUS PAINTS	A	2	BROOMS WITH HANDLE AND STAY	F	1
BLOCKSPLITTERS	F	1	BRUSHWARE	F	1
			BUILDING FILLER	C	1
C					
CARBARYL	E	1	CONCRETE HARDENERS - TOPPING	A	3
CAULK IN COLOURS	C	1	CONCRETE SLABS, PAVERS & STUMPS	A	3
CAULKING GUNS	C	1	CONTROLLED RELEASE FERTILISER	E	2
CEMENT EDGER	F	2	CULIVATOR	F	2
CLAW HAMMER	F	2	CUT OFF WHEELS - FLEXOUT	A	3
CONCRETE DISSOLVER	C	1			

TABLE OF CONTENTS

PAGE - 2

ITEM	SECTION	PG NO	ITEM	SECTION	PG NO
D					
DAMP COURSE AND FLASHINGS	A	4	DUCT/JOINING TAPE	A	5
DEPRESSED CENTRE GRINDING WHEEL	A	5	DUST MASK	F	2
DIAMOND BLADES	A	5	DUSTPAN SET	F	2
DOOR FRAMES METAL KNOCKDOWN	B	14	DYNAMIC LIFTER	E	2
E					
EAR MUFF	F	2	EASY FILLER MULTIPURPOSE, H/DUTY FILLER	C	2
EAR PLUGS	F	2	ECO - ORGANIC CROP PROTECTANT	E	2
EASY CLEAR SILICONE SEALANT	C	2	EXPANSION FOAM JOINT	A	5
EASY TILE CERAMIC ADHESIVE	C	2	EXPANSION TIES	A	6
F					
FERTILISERS	E	2	FORKS	F	3
FIRE DOOR FRAMES FOR MASONRY	B	9	FRAME FIXING DETAILS (MASONRY WALLS)	B	12
FIRE DOOR FRAMES FOR DRY WALL	B	10-11	FRAME FIXING DETAILS (DRY WALLS)	B	13
FIRE RATED DOOR FRAMES	B	16	FRAME TIES	A	6
FIRESOUND SEALANT	C	2	FULAFOAM - MAXFILL EXPANDING FOAM	C	2
FISKARS TOOLS	F	2	FULAPRENE 303 ADHESIVE SEALANT	C	2
FLAT FREE TYRES FITTED ON RIM	H	5	FULAPRENE 550 - POLYURETHANE SEALANT	C	2
FLOOR BOND	C	2	FUNGICIDE	E	3
FOIL FASTENERS	A	6			
G					
GAP FILLER	C	3	GARDEN EDGING STEEL	E	3
GEOTEXTILE FILTER FABRIC	D	1	GARDEN EDGING TIMBER	E	4
GLOVES	A	6	GARDEN LIME	E	4
GARDEN EDGING PEGS - METAL	E	3	GRATING - STEEL FRAME	D	1
GARDEN EDGING PEGS - PLASTIC	E	3	GRATING - STEEL GRATE	D	1
GARDEN EDGING PLASTIC	E	3	GYPSON	E	4
H					
HACKSAW	F	3	HOOP IRON & ACCESSORIES	A	7
HANDSAW	F	3	HOSE - GARDENA	G	1
HEDGE SHEARS	F	3	HOSE - OTHER BRAND	G	1
HESSIAN	A	6	HOSE NOZZLE, GUN ETC	G	1
HESSIAN BAGS	E	4	HOSE/TAP FITTINGS	G	1
HESSIAN TREE TIE	E	4	HOSE/TAP FITTINGS - JOINER	G	2
HOE	F	3	HYDRANGEA BLUEING/PINK	E	4

ITEM	SECTION	PG NO	ITEM	SECTION	PG NO
I					
INSECT TRAP	E	4	INSULATION (WATERPROOF LYNX WALLWRAP)	A	8
INSULATION BUILDING FOIL	A	7			
J					
JOIST HANGER	A	9	JOLLY TIES	E	4
JOIST STRAP	A	9			
K					
KNEELING BOARD	F	4	KNOCK DOWN FRAMES	B	3
KNIFE TRIMMING	F	3			
L					
LAWN FERTILISER	E	5	LEVELS (SPIRIT LEVELS)	F	4
LAWN GRUB KILLER	E	5	LIGHT DUTY WHEELBARROW - BOLTED	H	5
LAWN LEVELLERS	F	4	LIME SULPHUR	E	6
LAWN SEEDS	E	5	LINTELS	A	9
LAWN STARTER	E	6	LIQUID POTASH	E	12
LEAF CURL COPPER FUNGICIDE SPRAY	E	6	LOPPERS	F	4
LETTER BOXES	A	9	LUBRICANT	A	10
M					
M - BED GROUT	A	10	MATTOCKS	F	4
MALATHION	E	8	MAVRIK	E	7
MANCOZEB PLUS	E	6	MAX BOND CONSTRUCTION ADHESIVE	C	3
MANURE	E	6	MAX BOND FAST GRIP	C	3
MARKER DYE	E	6	MAX BOND P.V.A WOOD GLUE	C	3
MARKERS	F	4	MAX PRO SERIES	C	3
MASH HAMMER	F	4	MAX PRO SERIES STARTER PACKS	C	3
MASONARY HAMMER	F	5	MULTI GRIP	A	10
N					
NIPPERS	F	4	NEW GENERATION FRAMES (INTERIOR)	B	7
NO GROW 500 GLYPHOSATE	E	7	NEW GENERATION FRAMES (EXTERIOR)	B	8
O					
ORCHID FOOD	E	7	OXIDES - COLOUR - POWDER CEMENT	A	11
ORCHID POTTING MIX	E	7			

TABLE OF CONTENTS

PAGE - 4

ITEM	SECTION	PG NO	ITEM	SECTION	PG NO
P					
PAINT BRUSHES	F	4	PLASTIC U CHANNELS	D	2
PAINT ROLLER	F	4	PLIERS	F	4
PATHWEEDER	E	7	POLY TUBE	G	2
PEATMOSS	E	7	POST LIFT	F	5
PENCILS - CARPENTERS	F	4	POST RAMMER	F	5
PEST OIL	E	7	POST SUPPORTS	A	12
PITS & GRATES	D	1	PRIMER - RED - CLEANER	A	13
PLANT STARTER	E	7	PRO DRAIN	D	2
PLASTIC POLYTHENE FILM	A	12	PROTECTOR GLO - (LEATHER PROTECT, TYRE SHINE)	A	13
PLASTIC POLYTHENE FILM - HANDY ROLLS	A	12	PUMA BARROWS - (POLY & STEEL TRAY)	H	5
PLASTICIZER - MORTAR	A	12	PYRETHRUM	E	7
R					
RAIN ACCESSORIES	G	2	RETARDERS	A	13
RAGS	A	1	ROCOR RANGE	C	4
RAKES	F	5	ROOTEX	E	8
RAKE HOE	F	5	ROPES	A	13
RAPID SETTER - QUICK SETTER	A	13	ROSE BLACK SPOT	E	8
RAPID GRIP CONTACT ADHESIVE- GEL	C	3	ROSE GUN - INSECTICIDE	E	8
RAPID GRIP CONTACT ADHESIVE - LIQUID	C	3	ROUNDUP	E	8
RAT & MICE KILL - BAITS & TRAPS	E	8	RUBBER MALLETS	F	5
RESPIRATOR	A	13			
S					
SAFETY FENCE	A	12	SILICONE - INDUSTRIAL GRADE	C	4
SAFETY GLASSES	A	13	SILICONE - SEALANT 660	C	5
SAND AND SOIL BAGS	E	8	SILT FENCE	D	2
SAW	F	5	SLEDGE HAMMERS	F	6
SCALE GUN	E	8	SLEEPER STEEL BRACKETS	A	14
SEALERS	A	13	SLIDING DOOR FRAMES	B	6
SEED AND FERTILISER SPREADERS	F	5	SLIP RESISTANT POWDER	A	14
SEED RAISING MIX	E	9	SNAIL AND SLUG	E	9
SHADECLOTH	A	14	SOIL LEVELLER	F	6
SHOVELS	F	5	SOLVENTS	A	15
SILASEC	A	14	SOLVENTS CEMENT FOR PVC	A	15
SILICONE - FULLER TRADE	C	4	SPARE PARTS FOR PUMA BARROWS	H	5

ITEM	SECTION	PG NO	ITEM	SECTION	PG NO
SPARE PARTS FOR LIGHT DUTY BOLTED LEGS H		6	STEEL SECTIONS - END CAPS (PLASTIC)	A	17
SPILL ABSORBENT	A	15	STONE DUST AND CEMENT TOPPING	A	17
SPONGES	F	6	STORMWATER FITTINGS 100MM	D	2
SPRAYERS	E	9	STORMWATER FITTINGS 90MM	D	3
SPRAY PAINTS	A	15	STORMWATER PIPE	D	3
SPRAY BOND	C	5	STRAPS	A	17
SPRINKLERS	G	2	STRINGLINE	F	7
STAPLES	F	6	SUB SOIL PIPE	D	4
STANDARD DOOR FRAMES FOR DRY WALL	B	4	SUGAR CANE MULCH	E	10
STANDARD NON-RATED DOOR FRAMES	B	5	SULPHATE OF AMMONIA	E	10
STEEL POSTS	A	15	SULPHATE OF POTASH	E	10
STEEL SECTIONS	A	16	SUPERSEAL HPR	C	5
T					
TAPE MEASURES	F	7	TREE KILLER	E	11
TIN SNIPS	F	7	TREE STAC	E	11
TIMBER GUARD	A	18	TREE TIES	E	11
TIMBER STAKES	E	10	TRENCH MESH SUPPORT	A	17
TOOLBOX ADHESIVE SEALANT	C	5	TROWELS - BRICK & CONCRETE	F	7
TOP BOND	A	17	TYRE TUBES	H	6
TRADEMATE RANGE	C	5			
TREE AND BLACKBERRY KILLER	E	11			
U					
ULTRA CLEAR	C	6			
<i>UNDERGROUND WATERING SYSTEMS</i>					
SADDLE CLAMPS	G	3			
SHRUBBERS	G	3			
TEES	G	3			

TABLE OF CONTENTS

PAGE - 6

ITEM	SECTION	PG NO	ITEM	SECTION	PG NO
V					
VENTILATORS - SUB FLOOR	A	17			
VEGETABLE DUST	E	11			
W					
WALL TIES	A	18	WOODEN PEGS	E	13
WASP NEST DESTROYER	E	11	WHEELBARROWS WITH STEEL TRAY	H	1
WATERING CANS	E	11	WHEELBARROWS WITH PLASTIC TRAY	H	2
WATERPROOFER	A	18	LIGHT DUTY WHEELBARROWS	H	3
WEED AND FEED	E	11	IN KNOCK-DOWN KIT	H	3
WEED KILLER	E	11	NO FLAT TYRES	H	4
WEEDMASTER 360	E	12	FLAT FREE TYRES FITTED ON RIM	H	5
WEEDMATS (GROUND COVERS)	E	12	LIGHT DUTY WHEELBARROWS - BOLTED	H	5
WEEDMAT ACCESSORIES	E	12	PUMA BARROWS - POLY & STEEL TRAY	H	5
WELDED MESH PANELS	A	19	SPARE PARTS FOR PUMA BARROWS	H	6
WETTING AGENTS	E	12	SPARE PARTS FOR LIGHT DUTY BOLTED LEGS	H	7
WHITE OIL - INSECTICIDE	E	12	TYRE TUBES	H	7
WOODEN - FLOATS	F	8			
Z					
ZERO WEEDSPRAY	E	13			

BUILDING & HARDWARE

ANNEALED WIRE	1	BAR GUARDS	16
ANT CAP	1	STEEL SECTIONS	16
BAG OF RAGS	1	STEEL SECTIONS - END CAPS (PLASTIC)	17
BAG TIES	1	STONE DUST AND CEMENT TOPPING	17
BAR CHAIRS	1	STRAPS	17
BARRIER MESH	1	TIMBER GUARD	18
BARRIER TAPE	2	TOPBOND	18
BITUMINOUS PAINTS	2	TRENCH MESH SUPPORT	18
BONDCRETE	2	VENTILATORS - SUB FLOOR	18
BONDRITE	2	WALL TIES	18
BRICKWELD	2	WATERPROOFER	19
CONCRETE HARDENERS - TOPPINGS	3	WELDED MESH PANELS	19
CONCRETE SLABS & PAVERS	3		
CUT OFF WHEELS - FLEXOUT	3		
DAMPCOURSE AND FLASHINGS	4		
DEPRESSED CENTRE GRINDING WHEEL	5		
DIAMOND BLADE	5		
DUCT/JOINTING TAPE	5		
EXPANSION FOAM JOINT	5		
EXPANSION TIES	6		
FOIL FASTENERS	6		
FRAME TIES	6		
GLOVES	6		
HESSIAN	6		
HOOP IRON & ACCESSORIES	7		
INSULATION BUILDING FOIL	7		
INSULATION (WATERPROOF LYNX WALLWRAP)	8		
JOIST HANGER	9		
JOIST STRAP	9		
LETTER BOXES	9		
LINTELS	9		
LUBRICANT	10		
M - BED GROUT	10		
MULTI GRIP	10		
OXIDES - COLOUR - POWDER CEMENT	11		
PLASTIC POLYTHENE FILM	12		
PLASTIC POLYTHENE FILM - HANDY ROLLS	12		
PLASTICIZER - MORTAR	12		
POST SUPPORTS	12		
PRIMER - RED - CLEANER	13		
PROTECTOR GLO - LEATHER PROTECT, TYRE SHINE	13		
RAPID SETTER - QUICK SETTER	13		
RESPIRATOR	13		
RETARDERS	13		
ROPES	13		
SAFETY FENCE	13		
SAFETY GLASSES	13		
SEALERS	13		
SHADECLOTH	14		
SILASEC	14		
SLEEPER STEEL BRACKETS	14		
SLIP RESISTANT POWDER	14		
SOLVENTS	15		
SPILL ABSORBENT	15		
SPRAY PAINTS	15		
STEEL POSTS	15		



BUILDING & HARDWARE PRODUCTS

Description	Product Code	Box Qty
-------------	--------------	---------

ANNEALED WIRE**ANNEALED WIRE**

ANNEALED WIRE 1.57MM X 1.4KG	CREBAR30	10
--	----------	----

ANT CAP

ANT CAP WITH HOLE 100 X 100 X 50	WAC100X100H	1
ANT CAP PLAIN 100 X 100 X 50	WAC100X100P	1
ANT CAP WITH SLOT & HOLE 100 X 100 X 50	WAC100X100S	1

**BAG OF RAGS**

BAG OF RAGS 10KG T-SHIRT MIXBOR10A	1
--	---------	---

**BAG TIES****BAG TIES – BULK**

1.5MM X 110MM (2000 PIECES)	CBBT15110	1
1.5MM X 125MM (2000 PIECES)	CBBT15125	1
1.5MM X 150MM (2000 PIECES)	CBBT15150	1
1.5MM X 200MM (2000 PIECES)	CBBT15200	1

PREPACK BAG TIES

110MM X 1.5MM (200 PIECES)	CBHP15110	1
125MM X 1.5MM (200 PIECES)	CBHP15125	1
150MM X 1.5MM (200 PIECES)	CBHP15150	1

ROD TYING TOOL

CONCEPT ROD TYING TOOL (AUTO)	AHT	1
---	-----	---

BAR CHAIRS

RIGID BAR CHAIR 25/40 (100) - PALLET SIZE 50	RBC2540	1
RIGID BAR CHAIR 50/65 (100) - PALLET SIZE 60	RBC5065	1
RIGID BAR CHAIR 75/90 (100) - PALLET SIZE 40	RBC7590	1
RIGID BAR CHAIR 85/100 (100) - PALLET SIZE 40	RBC85100	1
RIGID BAR CHAIR CLIP TOP 50-65 (100) - PALLET SIZE 60	RBC5065C	1

**BARRIER MESH**

BARRIER MESH ORANGE 1M X 50M (7KG/ROLL)	LBM239	1
---	--------	---

Description

Product Code

Box Qty

**BARRIER TAPE**

BARRIER TAPE RED/WHITE D/SIDED 75MM X 100MBT100 16

BITUMINOUS PAINTS**ORANGE LABEL: BITUMINOUS RUBBERISED PLASTIC PAINT**

A HEAVY BRUSHABLE GRADE PROTECTIVE COATING FOR USE ON METAL & FIBRO ROOFS, SEALING BELOW GRADE RETAINING WALLS, GUTTERS, DOWNPIPES, ETC. IDEAL AS A SOUND DEADENER AND PROTECTIVE COATING IN CAR BODIES.

BITUMEN BRUSHABLE ORANGE LABEL 1LTR.....315176 6

BITUMEN BRUSHABLE ORANGE LABEL 4LTR.....315190 4

BITUMEN BRUSHABLE ORANGE LABEL 20LTR.....315206 1

RED LABEL: CEMENT COMPOUND

A PROTECTIVE BITUMEN PAINT AND ADHESIVE FOR USE ON ALL EXPOSED IRON AND METAL DOWNPIPES, GUTTERS, ETC...

BITUMEN PAINT RED LABEL 1LTR.....315060 6

BITUMEN PAINT RED LABEL 4LTR.....315084 4

SILVER SHIELD: BITUMINOUS PAINT

BITUMEN BASED HEAT REFLECTIVE SILVER ALUMPAINT FOR PROTECTING METAL, FIBRO AND BITUMINOUS ROOFING

BITUMEN PAINT SILVER SHIELD 4LTRV315039 4

BONDCRETE

THE ORIGINAL BONDING & SEALING AGENT - (ALSO REFER TO TOP BOND & BONDRITE)

BONDCRETE SQUEEZE PACK 500ML.....112005 12

BONDCRETE (PAIL) 1LTR.....123001 12

BONDCRETE (PAIL) 2LTR.....124008 6

BONDCRETE (PAIL) 4LTR.....125005 4

BONDCRETE (PAIL) 15LTR.....116004 1

BONDCRETE (PAIL) 20LTR.....117000 1

**BONDRITE****LYNX**

BONDING, SEALING & ADHESIVE AGENT.

BONDRITE 1LTR.....TW001250 12

BONDRITE 4LTR.....TW001267 4

BONDRITE 20LTR.....TW001274 1

**BRICKWELD**

BRICKWELD 4 LINE - 63MM X 50MTR ROLL.....TR562440 10

BRICKWELD 5 LINE - 85MM X 50MTR ROLL.....TR562488 8



BUILDING & HARDWARE PRODUCTS

Description	Product Code	Box Qty
-------------	--------------	---------

CONCRETE HARDENERS - TOPPINGS

HARDENER 20KG BLACK	ASCHA100 03	1
HARDENER 20KG BLUEGUM	ASCHA100 04	1
HARDENER 20KG BLUESTONE	ASCHA100 05	1
HARDENER 20KG BRICK RED	ASCHA100 06	1
HARDENER 20KG CHARCOAL	ASCHA100 11	1
HARDENER 20KG GREY	ASCHA100 18	1
HARDENER 20KG SANDSTONE	ASCHA100 27	1

**CONCRETE SLABS & PAVERS**

FULL PALLETS ONLY - DIRECT DELIVERY ONLY - MELBOURNE METRO

300 X 300 X 50 (80 PER PALLET)	CS300	1
450 X 450 X 50 (32 PER PALLET)	CS450	1
500 X 500 X 50 (28 PER PALLET)	CS500	1
600 X 600 X 50 (24 PER PALLET)	CS600	1

**CUT OFF WHEELS - FLEXOVIT****STAINLESS STEEL - MAXX INOX**

FLEXOVIT 100 X 1.0 X 16 M/I PREMIUM U/THIN	F15102010	100
FLEXOVIT 115 X 1.0 X 22 M/I PREMIUM U/THIN	F15115010	100
FLEXOVIT 125 X 1.0 X 22 M/I PREMIUM U/THIN	F15127010	100
FLEXOVIT 230 X 2.0 X 22 M/I PREMIUM U/THIN	F15230020	50

MASONRY

FLEXOVIT 102 X 16 X 3.2MM	F4010216	10
FLEXOVIT 115 X 22.2 X 3.2MM	F4011522	10
FLEXOVIT 125 X 22.2 X 3.2MM	F4012722	10

METAL

FLEXOVIT 100 X 16 X 2.5	F1010216	10
FLEXOVIT 115 X 22.2 X 2.5	F1011522	10
FLEXOVIT 125 X 22.2 X 2.5	F1012722	10
FLEXOVIT 178 X 22.2 X 2.5	F1017822	10
FLEXOVIT 230 X 22.2 X 2.5	F1023022	10
FLEXOVIT 230 X 25.0 X 2.5	F1023025	10

Description	Product Code	Box Qty
-------------	--------------	---------

DAMPCOURSE AND FLASHINGS**ALPROOF STANDARD / ALCOR**
.3MM BITUMEN COATED ALUMINUM

150MM X 10MTRV313035	1
230MM X 10MTRV313059	1
300MM X 10MTRV313073	1
350MM X 10MTRV313097	1

ALUFLASH ALUMINIUM/ADHESIVE BUTYL BACKED FLASHING
300MM X 5MTR

300MM X 5MTRV812391	1
--------------------	-----------	---

350MM X 5MTRV812414	1
--------------------	-----------	---

DAMPCOURSE/EMBOSSED POLYTHENE

110MM X 500UM X 30MTRV464089	18
-----------------------------	-----------	----

150MM X 500UM X 30MTRV464096	12
-----------------------------	-----------	----

230MM X 500UM X 30MTRV464102	8
-----------------------------	-----------	---

300MM X 500UM X 30MTRV464119	6
-----------------------------	-----------	---

380MM X 500UM X 30MTRV464126	4
-----------------------------	-----------	---

FLASHGUARD 10MTR

.3MM RAW ALUMINUM FLASHING

150MM X .3MM X 10MTRV314018	1
----------------------------	-----------	---

230MM X .3MM X 10MTRV314032	1
----------------------------	-----------	---

300MM X .3MM X 10MTRV314056	1
----------------------------	-----------	---

FLASHGUARD 20MTR

.3MM RAW ALUMINUM FLASHING

150MM X .3MM X 20MTRV314025	1
----------------------------	-----------	---

230MM X .3MM X 20MTRV314049	1
----------------------------	-----------	---

300MM X .3MM X 20MTRV314063	1
----------------------------	-----------	---

MALTHOID - VESFELT

2PLY BITUMEN FELT DAMPCOURSE (ALSO KNOWN AS MALTHOID)

110MM X 20MTRV466069	1
---------------------	-----------	---

150MM X 20MTRV466076	1
---------------------	-----------	---

230MM X 20MTRV466083	1
---------------------	-----------	---

300MM X 20MTRV466090	1
---------------------	-----------	---

350MM X 20MTRV466106	1
---------------------	-----------	---

450MM X 20MTRV466113	1
---------------------	-----------	---

VESFELT - ROOFING

2PLY BITUMEN FELT DAMPCOURSE (ALSO KNOWN AS MALTHOID)

1MTR X 20MTRV466021	1
--------------------	-----------	---

BUILDING & HARDWARE PRODUCTS

Description	Product Code	Box Qty
-------------	--------------	---------

DEPRESSED CENTRE GRINDING WHEEL

100 X 16 X 4.0 (METAL)	F6310240	1
115 X 22 X 6.0 (METAL)	F6311560	1

DIAMOND BLADE

230 X 25.4 / 22.2	F8034230	1
230 X 25.4 / 22.2 (CONCRETE, CLAY CUTTER)	F8040230	1

DUCT/JOINTING TAPE

DUCT TAPE 48MM X 30MTR (SILVER)	JT	60
---	----	----

**EXPANSION FOAM JOINT****FLEXIJOINT (10MM)**

FLEXIJOINT 50MM X 25MTR	EJF050	24
FLEXIJOINT 75MM X 25MTR	EJF075	16
FLEXIJOINT 100MM X 25MTR	EJF100	12
FLEXIJOINT 125MM X 25MTR	EJF125	10
FLEXIJOINT 150MM X 25MTR	EJF150	8
FLEXIJOINT 200MM X 25MTR	EJF200	6
FLEXIJOINT 250MM X 25MTR	EJF250	5
FLEXIJOINT 300MM X 25MTR	EJF300	4

**FLEXIJOINT - HANDY ROLLS (10MM)**

FLEXIJOINT HANDY ROLLS 75MM X 6MTR	EJF075HANDY	16
FLEXIJOINT HANDY ROLLS 100MM X 6MTR	EJF100HANDY	12

FLEXIJOINT - STICKY BACK (10MM)

STICKY BACK FLEXIJOINT 50MM X 25MTR	EJF050A	24
STICKY BACK FLEXIJOINT 75MM X 25MTR	EJF075A	16
STICKY BACK FLEXIFOAM 100MM X 25MTR	EJF100A	12
STICKY BACK FLEXIJOINT 125MM X 25MTR	EJF125A	10
STICKY BACK FLEXIJOINT 150MM X 25MTR	EJF150A	8
STICKY BACK FLEXIJOINT 200MM X 25MTR	EJF200A	6
STICKY BACK FLEXIJOINT 250MM X 25MTR	EJF250A	5
STICKY BACK FLEXIJOINT 300MM X 25MTR	EJF300A	4



BUILDING & HARDWARE PRODUCTS

Description	Product Code	Box Qty
JOINTFORM		
<i>8.5MM BITUMEN IMPREGNATED CANEITE EXP JOINTING</i>		
CONFORM JOINTFORM 75MM X 8.5MM X 2.44MTRV323027	1
CONFORM JOINTFORM 100MM X 8.5MM X 2.44MTRV323034	1
CONFORM JOINTFORM 125MM X 9.0MM X 2.44MTRV323430	1
CONFORM JOINTFORM 150MM X 9.0MM X 2.44MTRV323447	1

EXPANSION TIES

EXPANSION TIE PLASTIC SLIDE 300MM (BOX 50)	CGTIP	1
EXPANSION TIE STAINLESS STEEL PLASTIC SLEEVE (BOX 25) ETPSS	CGTIPSS	1
GALV EXPANSION TIE (BOX 20)	ETZ600	1
STAINLESS STEEL EXPANSION TIE (BOX 20)	ETSS316	1
ABEY		
EXPANSION TIE GALV V SHAPE 45MM X 280MM (20)	AB0610	1

FOIL FASTENERS

ABEY		
FOIL FASTENERS (BOX 500)	FF3	1

FRAME TIES

ABEY		
FRAME TIES GALV 230MM X 0.8MM (QTY 150)	AB0504	1

**GLOVES**

GLOVE RED PVC SINGLE DIP SIZE 10 (12) PACK	GLOVE440045	1
GLOVE ALL PURPOSE SIZE 9 (12) PACK	GLOVE1030	1
GLOVE CATGRIP ALL PURPOSE SIZE 10 (12) PACK	GLOVE44303610	1
GLOVE BEIGE RIGGER (LARGE) BLUE BAND (12) PACK	GLOVERIGUL	1
GLOVE NINJA SIZE 9 (12) PACK	GLOVE4001	1
GLOVE RIGGERS LARGE JERSEY LINED (12) PACK	GRIG	1
GLASS & BRICK GRIPPER (12) PACK	JGA0010	1
GLOVE SOLVENT RESISTANT GREEN NITRILE H/DUTY SIZE 9 (12 PACK)	GLOVE2030HVY	1

HESSIAN

USED BY TRADESMEN, ESPECIALLY CONCRETTERS

180CM X 50YDS BOLT 14OZ HESSIAN	HSS1850A	21
180CM X 50MTR BOLT 18OZ HESSIAN	HSS1850M	21



BUILDING & HARDWARE PRODUCTS

Description	Product Code	Box Qty
HOOP IRON & ACCESSORIES		
HOOP IRON TENSIONER WINGNUT (25 BAGS OF 6)	WTENX6	1
TENSIONERS WINGNUT (QTY 150)	WTEN	1
HOOP IRON TENSIONER (BULK) 150W SCREWS.....	WTENWSB	1
HOOP IRON TENSIONER W.SCREW (25 BAGS OF 6)	WTENWSX6	1
.6 GAUGE		
LIGHT HOOP IRON 25MM X 15MTR.....	H15	5
LIGHT HOOP IRON 25MM X 30MTR.....	H30	5
LIGHT HOOP IRON 25MM X 6MTR.....	H6	5
.8 GAUGE		
HEAVY HOOP IRON 30MM X 15MTR.	H15H	5
HEAVY HOOP IRON 30MM X 30MTR.	H30H	5
HEAVY HOOP IRON 30MM X 50MTR.	H50H	5
HEAVY HOOP IRON 30MM X 6MTR.	H6H	5
PUNCHED		
HOOP IRON 30MM X 1.0MM X 30MTR.	W30130M	1

**INSULATION BUILDING FOIL**

LYNX		
1350MM X 20MTR SUPER TOUGH ROOF & WALL WRAP	FSB4	56
1350MM X 60MTR SUPER TOUGH ROOF & WALL WRAP	FSB5	56
1350MM X 20MTR SUPER TOUGH WALL WRAP WITH BREATHER.....	FSB6	56
1350MM X 60MTR SUPER TOUGH WALL WRAP WITH BREATHER.....	FSB7	56



LYNX

WALLWRAP**WATERPROOF INSULATION****Heavy Duty Superstrong -
Antiglare Finish****USE:**

SUPERSTRONG is ideal for use as an external wall wrap for dwellings as a protective barrier.

It is also extremely well suited for a variety of commercial/industrial applications where a strong, durable and waterproof insulation is required.

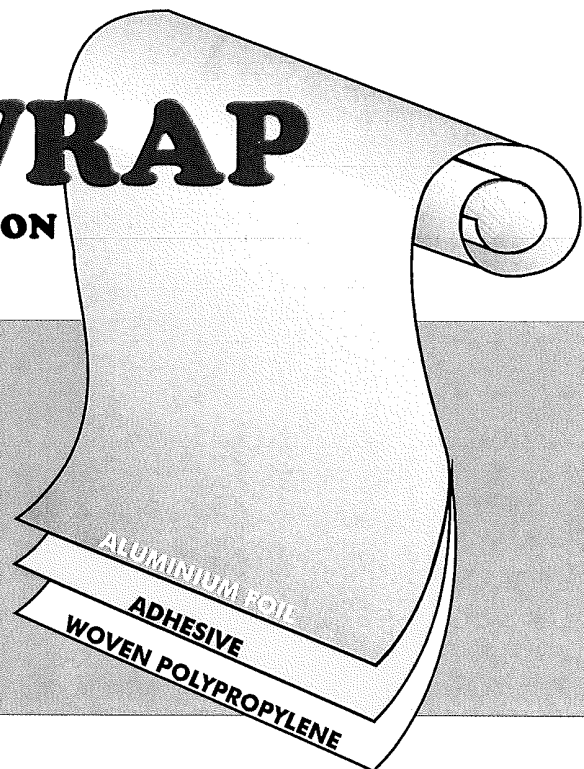
**DESCRIPTION:**

Superstrong Insulation consists of a layer of aluminium reflective foil laminated to a woven polypropylene mesh to form a rugged, durable aluminium foil insulation product.

VAPOUR BARRIER:

SUPERSTRONG provides an excellent barrier against water vapour. When overlapped and taped **SUPERSTRONG** assists in preventing condensation to walls.

DURABILITY:

The combination of woven polypropylene fabric laminated to aluminium reflective foil provides a highly durable pleasing to handle waterproof building membrane

FLAME RETARDANT:

When tested in accordance with Australian Standard 1530 part 2, **SUPERSTRONG** has a very low flammability index of 1.

Supplied by:

**Fairbanks Building &
Garden Supplies**
(03) 9357 8600

Glenbarry Road, Campbellfield
Victoria 3061

STANDARDS COMPLIANCE:

SUPERSTRONG complies with all the requirements of AS/NZS 4200.1:1994 as a Heavy Duty Foil.

PHYSICAL PROPERTIES:

Tested in accordance and complies with the requirements of Australian Standard AS/NZS 4200.1: 1994.

Resistance to dry delamination	Pass
Resistance to wet delamination	Pass
Shrinkage	Less than 0.5%
Folding endurance	
- Machine direction	>2.0
- Lateral direction	>1.70
Duty	Heavy
Tensile strength	
- Machine direction	>9.5kN/m
- Lateral direction	>6.0N/m
Edge tear resistance	
- Machine direction	>65N
- Lateral direction	>65N
Vapour barrier	High
Emmittance	High
Water barrier	High
Flammability index	Unclassified

Width mm	Length m	Area m ²	Approx. Weight Kg
1350	20	27	4
1350	60	81	11

BUILDING & HARDWARE PRODUCTS

Description	Product Code	Box Qty
-------------	--------------	---------

JOIST HANGER**35MM**

35 X 90 (QTY 45)	WJH35X90	1
------------------------	----------	---

38MM

38 X 140 (QTY 30)	WJH38X140	1
-------------------------	-----------	---

38 X 180 (QTY 30)	WJH38X180	1
-------------------------	-----------	---

45MM

45 X 90 (QTY 45)	WJH45X90	1
------------------------	----------	---

45 X 120 (QTY 30)	WJH45X120	1
-------------------------	-----------	---

45 X 140 (QTY 30)	WJH45X140	1
-------------------------	-----------	---

45 X 180 (QTY 30)	WJH45X180	1
-------------------------	-----------	---

45 X 220 (QTY 20)	WJH45X220	1
-------------------------	-----------	---

**JOIST STRAP****WILMAPLEX**

JOIST STRAP 150MM (QTY 150)	WJS	1
-----------------------------------	-----	---

**LETTER BOXES****ALUMINIUM PLAIN**

FRONT 9" X 6 1/2"	LF	10
-------------------------	----	----

COMBINATION 9" X 6 1/2"	LCF	10
-------------------------------	-----	----

PAPER FRONT 9" X 6 1/2"	LPF	10
-------------------------------	-----	----

BACK 9" X 6 1/2"	LB	10
------------------------	----	----

FRONT & BACK SET 9" X 6 1/2"	LFBS	10
------------------------------------	------	----

**LINTELS****FLAT BAR GALVANISED**

900MM X 85 X 7	FLF85900A	1
----------------------	-----------	---

1000MM X 85 X 7	FLF851000A	1
-----------------------	------------	---

1200MM X 85 X 7	FLF851200A	1
-----------------------	------------	---

BUILDING & HARDWARE PRODUCTS

Description	Product Code	Box Qty
STRUCTURAL LINTELS - HOT DIPPED GALVANISED		
900MM X 100 X 100 X 6 FLL100900A	1
1000MM X 100 X 100 X 6	FLL1001000A	1
1200MM X 100 X 100 X 6	FLL1001200A	1
1500MM X 100 X 100 X 6	FLL1001500A	1
1800MM X 100 X 100 X 6	FLL1001800A	1
2100MM X 100 X 100 X 6	FLL1002100A	1
2400MM X 100 X 100 X 6	FLL1002400A	1
2700MM X 100 X 100 X 6	FLL1002700A	1
3000MM X 100 X 100 X 6	FLL1003000A	1

ABOVE 3M LENGTHS COUNTRY CUSTOMERS (DIRECT DELIVERIES) PAY THEIR OWN FREIGHT

LUBRICANT

MULTI PURPOSE LUBRICANT 60G AEROSOL	DYM42030601	12
MULTI PURPOSE LUBRICANT 400G AEROSOL	DYM42034002	12

M - BED GROUT

AN EXPANDING NON-SHRINK CONSTRUCTION GROUT FOR GROUTING MACHINE BASES, ANCHOR BOLTS AND SIMILAR GROUTING APPLICATIONS.

M-BED GROUT 20KGV316401	1
----------------------------	----------	---

MULTIGRIP

WILMAPLEX MULTIGRIP 100MM (50)	WMG100	1
--	--------	---



BUILDING & HARDWARE PRODUCTS

Description	Product Code	Box Qty
OXIDES - COLOUR - POWDER CEMENT		
BLACK OXIDE 1KG	OBLACK83801	1
BLACK OXIDE 2KG	OBLACK83802	1
BLACK OXIDE 4KG	OBLACK83804	1
BLACK OXIDE 12.5KG	OBLACK838012	1
TRUSTCOLOR BLACK OXIDE 25KG.	OBLACK831825A	1
TERRACOTTA RED OXIDE 1KG	ORED81101	1
TERRACOTTA RED OXIDE 2KG	ORED81102	1
TERRACOTTA RED OXIDE 4KG	ORED81104	1
TRUE RED OXIDE 1KG.	ORED81301	1
TRUE RED OXIDE 2KG.	ORED81302	1
TRUE RED OXIDE 4KG.	ORED81304	1
DARK BROWN OXIDE 1KG	OBR86861	1
DARK BROWN OXIDE 2KG	OBR86862	1
DARK BROWN OXIDE 4KG	OBR86864	1
DARK BROWN OXIDE 25KG	ODARKBROWN25	1
MAHOGANY OXIDE 1KG	OBR86601	1
MAHOGANY OXIDE 2KG	OBR86602	1
MAHOGANY OXIDE 4KG	OBR86604	1
TAN BROWN OXIDE 1KG	OBR86101	1
TAN BROWN OXIDE 2KG	OBR86102	1
YELLOW OXIDE 1KG	OY89201	1
YELLOW OXIDE 2KG	OY89202	1
OXIDE BLUESTONE 1KG	OBLUESTONE1	1
OXIDE BLUESTONE 2KG	OBLUESTONE2	1
OXIDE BLUESTONE 4KG	OBLUESTONE4	1
SANDSTONE OXIDE 1KG	OSAND1	1
SANDSTONE OXIDE 2KG	OSAND2	1
CHROME GREEN OXIDE 1KG	OCG1	1
CHROME GREEN OXIDE 2KG	OCG2	1

Description	Product Code	Box Qty
PLASTIC POLYTHENE FILM		
BLACK		
LYNX BLK 4MTR X 200UM X 50MTR CONCRETE UNDERLAY.....	GBB420050LYNX	36
BLACK POLYTHENE 2MTR X 50UM X 200MTR.....	GBB250200	36
BLACK POLYTHENE 2MTR X 100UM X 100MTR.....	GBB2100100	36
BLACK POLYTHENE 2MTR X 200UM X 50MTR.....	GBB220050	36
BLACK POLYTHENE 4MTR X 200UM X 50MTR.....	GBB420050	36
BLACK POLYTHENE (W/FOLD) 4MTR X 200UM X 50MTR	GBBSPEC5	25
CLEAR		
CLEAR POLYTHENE FILM 2MTR X 200UM X 50MTR.....	GBN220050	36
GREENHOUSE		
GREENHOUSE FILM NATURAL 2MTR X 100UM X 100MTR.....	GBN2100100G	1
HIGH IMPACT		
HIGH IMPACT BLACK PLASTIC 4MTR X 200UM X 50MTR	GBBHI420050	36

PLASTIC POLYTHENE FILM - HANDY ROLLS

BLACK HANDY PACKS - 100UM		
BLACK POLYTHENE 2MTR X 100UM X 5MTR.....	GBHB21005	10
BLACK POLYTHENE 2MTR X 100UM X 10MTR.....	GBHB210010	10
BLACK POLYTHENE 2MTR X 100UM X 20MTR.....	GBHB210020	6
BLACK HANDY PACKS - 200UM		
BLACK POLYTHENE 2MTR X 200UM X 5MTR.....	GBHB22005	9
BLACK POLYTHENE 2MTR X 200UM X 10MTR.....	GBHB220010	6
BLACK POLYTHENE 2MTR X 200UM X 20MTR.....	GBHB220020	72

PLASTICIZER - MORTAR

LYNX

USED IN BRICK MORTAR TO IMPROVE COHESION AND REDUCE BLEED

MORTAR PLASTICIZER 2.5LTR.....	TW600221	8
MORTAR PLASTICIZER 5LTR.....	TW600223	4
MORTAR PLASTICIZER 20LTR.....	TW600224	1



POST SUPPORTS

POST SUPPORT BOLT DOWN

BOLT DOWN 90MM.....	PABD90	10
BOLT DOWN 100MM.....	PABD100	10



BUILDING & HARDWARE PRODUCTS

Description	Product Code	Box Qty
PRIMER - RED - CLEANER		
RED PRIMER 250ML.....	P250	36
RED PRIMER 500ML.....	P500	24
PROTECTOR GLO - LEATHER PROTECTOR, TYRE SHINE		
PROTECTOR GLO 1LTR	PJPROGLO1	1
RAPID SETTER - QUICK SETTER		
FAIRBANKS RAPID SET		
CONCRETE RAPID SETTER 5LTR.....	PQ5	4
CONCRETE RAPID SETTER 20LTR.....	PQ20	1
RESPIRATOR		
RESPIRATOR		
P2 VALVED DISPOSABLE (BOX 10)	RES600622	1
RETARDERS		
AGG-CRETE SURFACE RETARDER 20LTR	ASCAGGCRETE20	1
MBT EXPOSE 20LTR BLUE DRUM	ASCSE800 30	1
ROPES		
LAI D POLYETHYLENE SILVER		
10MM X 125MTR	ROS1003	1
SAFETY FENCE		
LYNX		
BARRIER MESH (SAFETY) ORANGE P/E 1M X 50MTR (7KG).	LBM239	1
SAFETY GLASSES		
GLASSES ROUGE SAFETY CLEAR	GLASS900095	12
GLASSES ROUGE SAFETY SMOKE	GLASS900096	12
SEALERS		
SEALER CLEAR 10LTR	ASCSE110 00	1
SEALER CLEAR 20LTR	ASCSE120 00	1
SEALER CHARCOAL 20LTR - DARK.	ASCSE120 11D	1

**RESPIRATOR****RESPIRATOR**

P2 VALVED DISPOSABLE (BOX 10) RES600622 1

RETARDERS

AGG-CRETE SURFACE RETARDER 20LTR

MBT EXPOSE 20LTR BLUE DRUM ASCSE800 30 1

ROPES**LAI D POLYETHYLENE SILVER**

10MM X 125MTR ROS1003 1

SAFETY FENCE**LYNX**

BARRIER MESH (SAFETY) ORANGE P/E 1M X 50MTR (7KG). LBM239 1

SAFETY GLASSES

GLASSES ROUGE SAFETY CLEAR

GLASSES ROUGE SAFETY SMOKE

SEALERS

SEALER CLEAR 10LTR

SEALER CLEAR 20LTR

SEALER CHARCOAL 20LTR - DARK.



Description	Product Code	Box Qty
-------------	--------------	---------

SHADECLOTH

CONTACT OFFICE FOR PRICING



SILASEC

THE PERFECT MASONRY WATERPROOFING/POND USE.

SILASEC 4LTR.V225001	4
-----------------------	----------	---

SLEEPER STEEL BRACKETS

SINGLE BRACKET 450MM	JRS470	1
DOUBLE BRACKET 900MM	JRS710	1
STEEL CORNER L50 X 700 L/H GALV	JRS3186GAL	1
STEEL CORNER L50 X 700 R/H GALV.	JRS3179GAL	1
STEEL END L50 X 700 GALV.	JRS3193GAL	1
STEEL END L50 X 400 GALV.	JRS3148GAL	1
STEEL JOINER L50 X 700 GALV	JRS3131GAL	1
STEEL JOINER L50 X 400 GALV	JRS3209GAL	1
STEEL CORNER L50 X 400 L/H GALV	JRS3162GAL	1
STEEL CORNER L50 X 400 R/H GALV.	JRS3155GAL	1



SLIP RESISTANT POWDER

SLIP RESISTANT POWDER 300GM	ASCSE100 99	1
---------------------------------------	-------------	---

SOLVENTS

SOLVENT 10LTR	ASCSE150 10	1
SOLVENT 20LTR	ASCSE150 20	1

SOLVENT CEMENT FOR PVC

BLUE 250ML	SCE250	18
BLUE 500ML	SCE500	18

SPILL ABSORBENT

SUPER ABSORBENT 10KG	SA10	1
SUPER ABSORBENT 50KG	SA50	1



Description	Product Code	Box Qty
SPRAY PAINTS		
BALCHAN		
SURVEY PAINT BRILLIANT WHITE 350G	S1806R	12
SURVEY PAINT BRILLIANT BLUE 350GM	S1812R	12
SURVEY PAINT BRILLIANT ORANGE 350GM	S1813R	12
SURVEY PAINT BRILLIANT PINK 350GM	S1814R	12
SURVEY PAINT BRILLIANT YELLOW 350GM	S1816R	12
DYMARK		
WHITE LINE MARKING PAINT 500G	S1526	12
WHITE SPRAY & MARK PAINT 350G	S1806	12
FLURO RED SPRAY & MARK PAINT 350G	S1811	12
FLURO BLUE SPRAY & MARK PAINT 350G	S1812	12
FLURO ORANGE SPRAY & MARK PAINT 350G	S1813	12
FLURO PINK SPRAY & MARK PAINT 350G	S1814	12
FLURO GREEN SPRAY & MARK PAINT 350G	S1815	12
FLURO YELLOW SPRAY & MARK PAINT 350G	S1816	12
LYNX		
FLURO ORANGE SPOT MARKING PAINT 350G	S1813L	12

STEEL POSTS

'Y' SHAPE STEEL POSTS WITH HOLES IN VARIOUS SPACING (10 UNITS PER BUNDLE)

450MM (10) SDL450	1
600MM (10) SDL600	1
900MM (10) SDL900	1
1350MM (10) SDL135	1
1500MM (10) SDL150	1
1650MM (10) SDL165	1
1800MM (10) SDL180	1
2100MM (10) SDL210	1
2400MM (10) SDL240	1

BAR GUARDS

YELLOW ROUND (100) BG 1

Y POST BRACKET

BRACKET FOR STEEL FENCE POSTS GALVANISED (50) JRS 1

RIGHT ANGLE BRACKET

BRACKET RIGHT ANGLED 80MM X 180MM GALVANISED (100) JRS1 1



Description	Product Code	Box Qty
-------------	--------------	---------

STEEL SECTIONS

C-SECTION TAPERED

100 X 50 "C" HDG BEAM 1000MM TAPERED	CSECT1000A	1
100 X 50 "C" HDG BEAM 1200MM TAPERED	CSECT1200A	1
100 X 50 "C" HDG BEAM 1500MM TAPERED	CSECT1500A	1
100 X 50 "C" HDG BEAM 1800MM TAPERED	CSECT1800A	1
100 X 50 "C" HDG BEAM 2100MM TAPERED	CSECT2100A	1
100 X 50 "C" HDG BEAM 2400MM TAPERED	CSECT2400A	1
100 X 50 "C" HDG BEAM 2700MM TAPERED	CSECT2700A	1
100 X 50 "C" HDG BEAM 3000MM TAPERED	CSECT3000A	1
100 X 50 "C" HDG BEAM 900MM TAPERED	CSECT900A	1

C-SECTION TAPERED

100 X 50 "C" HDG BEAM 1000MM PARALLEL.	CSECT1000P	1
100 X 50 "C" HDG BEAM 1200MM PARALLEL.	CSECT1200P	1
100 X 50 "C" HDG BEAM 1500MM PARALLEL.	CSECT1500P	1
100 X 50 "C" HDG BEAM 1800MM PARALLEL.	CSECT1800P	1
100 X 50 "C" HDG BEAM 2100MM PARALLEL.	CSECT2100P	1
100 X 50 "C" HDG BEAM 2400MM PARALLEL.	CSECT2400P	1
100 X 50 "C" HDG BEAM 2700MM PARALLEL.	CSECT2700P	1
100 X 50 "C" HDG BEAM 3000MM PARALLEL.	CSECT3000P	1
100 X 50 "C" HDG BEAM 900MM PARALLEL	CSECT900P	1

ECONO "C"

ECONO "C" SECTION 600MM (SUITS 50MM SLEEPERS)	ECONOC600	1
ECONO "C" SECTION 900MM (SUITS 50MM SLEEPERS)	ECONOC900	1
ECONO "C" SECTION 1200MM (SUITS 50MM SLEEPERS)	ECONOC1200	1

H-SECTION

100 X 100 "H" HDG BEAM 900MM	HSECT900A	1
100 X 100 "H" HDG BEAM 1000MM	HSECT1000A	1
100 X 100 "H" HDG BEAM 1200MM	HSECT1200A	1
100 X 100 "H" HDG BEAM 1500MM	HSECT1500A	1
100 X 100 "H" HDG BEAM 1800MM	HSECT1800A	1
100 X 100 "H" HDG BEAM 2100MM	HSECT2100A	1
100 X 100 "H" HDG BEAM 2400MM	HSECT2400A	1
100 X 100 "H" HDG BEAM 2700MM	HSECT2700A	1
100 X 100 "H" HDG BEAM 3000MM	HSECT3000A	1
ECONO "H" SECTION 600MM (SUITS 50MM SLEEPERS)	ECONOH600	1
ECONO "H" SECTION 900MM (SUITS 50MM SLEEPERS)	ECONOH900	1

BUILDING & HARDWARE PRODUCTS

Description	Product Code	Box Qty
ECONO "H" SECTION 1200MM (SUITS 50MM SLEEPERS)	ECONOH1200	1
90 DEGREE CORNER C-SECTION		
100MM X 50MM 90 DEGREE CORNER "C" SECTION 900MM	WDCSECT900A	1
100MM X 50MM 90 DEGREE CORNER "C" SECTION 1200MM	WDCSECT1200A	1
100MM X 50MM 90 DEGREE CORNER "C" SECTION 1500MM	WDCSECT1500A	1
100MM X 50MM 90 DEGREE CORNER "C" SECTION 1800MM	WDCSECT1800A	1
100MM X 50MM 90 DEGREE CORNER "C" SECTION 2100MM	WDCSECT2100A	1
100MM X 50MM 90 DEGREE CORNER "C" SECTION 2400MM	WDCSECT2400A	1
100MM X 50MM 90 DEGREE CORNER "C" SECTION 2700MM	WDCSECT2700A	1
100MM X 50MM 90 DEGREE CORNER "C" SECTION 3000MM	WDCSECT3000	1
ECONO 90 DEGREE		
ECONO 90 DEGREE CORNER 600MM (SUITS 50MM SLEEPERS)	ECONO90600	1
ECONO 90 DEGREE CORNER 900MM (SUITS 50MM SLEEPERS)	ECONO90900	1
ECONO 90 DEGREE CORNER 1200MM (SUITS 50MM SLEEPERS)	ECONO901200	1
45 DEGREE CORNER C-SECTION		
ECONO 45 DEGREE CORNER 600MM (SUITS 50MM SLEEPERS)	ECONO45600	1
ECONO 45 DEGREE CORNER 900MM (SUITS 50MM SLEEPERS)	ECONO45900	1
ECONO 45 DEGREE CORNER 1200MM (SUITS 50MM SLEEPERS)	ECONO451200	1



STEEL SECTIONS - END CAPS (PLASTIC)

100MM SECTIONS

"H" SECTION GREY END CAP (BOXED 20)	HCAPGREY	10
---	----------	----

STONE DUST AND CEMENT TOPPING

STONE DUST AND CEMENT TOPPING 20 KGSD20	50
*PLUS FREIGHT (MELB METRO FIS)		

STRAPS

FASTY STRAPS

DISPLAY CARTON (40 ASSORTED STRAPS)	FASTY120	1
1.0MTR X 25MM WHITE (10 STRAPS PER PACK)	FASTY121A	1
1.5MTR X 25MM YELLOW (10 STRAPS PER PACK)	FASTY122A	1
2.0MTR X 25MM BLUE (10 STRAPS PER PACK)	FASTY123A	1
2.5MTR X 25MM RED (10 STRAPS PER PACK)	FASTY124A	1
3.5MTR X 25MM BLACK (10 STRAPS PER PACK)	FASTY125A	1
5MTR X 25MM BLACK SINGLE PACK	FASTY191	1
FASTY HOOKS		
10MTR X 50MM 2PCE HOOKS 4000KG ORANGE	FASTY189	1

Description	Product Code	Box Qty
-------------	--------------	---------

TIMBER PRESERVATIVE

ECO SEAL TIMBER PRESERVATIVE 300G GREEN.....	RLAECOSEAL	12
CLEAR ENSEAL TIMBER PRESERVATIVE 300G.....	RLAENSEAL	12

TIMBER GUARD

TIMBER GUARD 45MM X 25MTR.....	TG4525	1
TIMBER GUARD 70MM X 15MTR.....	TG7015	1
TIMBER GUARD 90MM X 12MTR.....	TG9012	1

TOPBOND

ACRYLIC BONDING AGENT

GENERAL PURPOSE PRIMER AND ADMIXTURE FOR CEMENT BASED MORTAR & RENDER

TOPBOND 5LTR.	TW600229	4
-----------------------	----------	---

TRENCH MESH SUPPORT

TRENCH MESH SUPPORT (25) - PALLET SIZE 120	TMS	1
--	-----	---

VENTILATORS - SUB FLOOR

CONVENTIONAL VENT

CONVENTIONAL 230 X 75 (20 PER BOX)	AB0402	1
CONVENTIONAL 230 X 165 (20 PER BOX) - DOUBLE BRICK BENT.....	AB0401	1

MAGPIE VENTS

VENTS MAGPIE 255 X 90	AB0427	1
-----------------------------	--------	---

SLIMLINE VENTS

SLIMLINE VENT 230 X 75 ABEY (20 PER BOX)	AB0400	1
--	--------	---

VENTS WITH MESH

SLIMLINE VENT	AB0400M	1
VENT 230MM X 75MM WITH MESH.....	AB0402M	1
VENT 230MM X 165MM WITH MESH.....	VENT230165M	1

WALL TIES

WIRE CAVITY TIE

ABEY STAYFIX S/STEEL WALL TIES (QTY 500) DOUBLE LOOP.....	AB0602/500	1
---	------------	---

FACE FIXING BRICK VENEER TIES - SHERRIFF

SHERRIFF TIES GALV WITH NAILS L/DUTY (QTY 150)	AB1000	350
SHERRIFF TIES S/STEEL WITH NAILS L/DUTY (QTY 150).....	AB1004	1
SHERRIFF FACE FIXING GALV MEDIUM DUTY WITH SCREWS (QTY 150)	AB1010	1

BUILDING & HARDWARE PRODUCTS

Description	Product Code	Box Qty
FACE FIXING BRICK VENEER TIES		
WILAMPLEX WALL TIES SLIM WITH NAILS (QTY 150) - PALLET 256.	WWTS	1
WALL TIE FACE 4 1/2' - 20MM WIDTH (QTY 150)	WWTF	1
WILAMPLEX STAINLESS WALL TIE (150)	LWTSS	
WIRE CAVITY TIES		
50MM DOUBLE RING CAVITY (10 BAGS OF 50).WTSL31R	1
U-SHAPE CAVITY: 90MM MEDIUM DUTY (10 BAGS OF 50)	WTSB31R	1
U-SHAPE CAVITY: 90MM HEAVY DUTY (10 BAGS OF 25)	WTSB40R	1
U-SHAPE CAVITY: 120MM HEAVY DUTY (10 BAGS OF 25)	WTHB40R	1
SIDE FIXING		
ABEY SIDE FIXING TIES GALV 142MM (150)	AB1001	1

**WATERPROOFER****AMMONIA**

WATERPROOFER TO BE USED IN RENDER/MORTAR OR CEMENT MIXES.

WATERPROOFER WHITE 5LTR	TW600225	4
WATERPROOFER WHITE 20LTR.....	TW600226	1

BRICKIES

WATERPROOFER TO BE USED ONLY IN BRICK MORTAR.

WATERPROOFER BRICKIES RED 5LTR	TW600237	4
WATERPROOFER BRICKIES RED 20LTR.....	TW600238	1

**WELDED MESH PANELS**

MINIMUM OF 20 PANELS MIXED (PACKS OF 5)

2.4M X 1.2MTR

WELDED MESH PANEL 25MM X 25MM X 2.5.....	WMP2525	5
WELDED MESH PANEL 25MM X 50MM X 2.5.....	WMP2550	5
WELDED MESH PANEL 50MM X 50MM X 3.15.....	WMP5050	5
WELDED MESH PANEL 50MM X 50MM X 4.0.....	WMP5050SPEC4	5
WELDED MESH PANEL 50MM X 75MM X 4.0.....	WMP5075	5
WELDED MESH PANEL 100MM X 100MM X 5.0.....	WMP100100	5



DOOR PRODUCTS

METAL DOOR FRAMES

GENERAL INFORMATION	1
ASSEMBLED FRAMES	2
KNOCK DOWN FRAMES	3
STANDARD DOOR FRAMES FOR DRY WALLS	4
STANDARD NON-RATED DOOR FRAMES	5
SLIDING DOOR FRAMES	6
NEW GENERATION FRAMES - INTERIOR	7
NEW GENERATION FRAMES - EXTERIOR	8
FIRE DOOR FRAMES FOR MASONRY	9
FIRE DOOR FRAMES FOR DRY WALL	10-11
FRAME FIXING DETAILS FORMASONRY WALLS	12
FRAME FIXING DETAILS FOR DRY WALLS	13

PRICELIST

ACCESS DOORS SUBFLOOR	14
DOOR FRAMES METAL KNOCKDOWN	14
FIRE RATED DOOR FRAMES	16

B

METAL DOOR FRAMES

GENERAL INFORMATION

Assembled And Knock Down Frames:

These frames are supplied with:

1. One pair of 100x 75 mm 1.6mm zinc plated loose pin butt hinges projection welded into position.
2. A universal stainless steel striker plate positioned at standard location.
3. One pair of rubber buffers fitted to the lock stile.
4. Removable spreader bars.
5. Ramset plates to each stile.
6. Ten galvanised wire ties.
7. Projection welded corners when supplied as factory assembled frames.

Available Extras:

1. Additional hinges.
2. Preparation for special lock strikers.
3. Preparation for non-standard lock height
4. Reinforced for surface mounted closers or preparation for concealed closers.
5. Preparation for screw fixed hinges.
6. Tube fixing for bolting of frames to existing walls.



METAL DOOR FRAMES

ASSEMBLED FRAMES

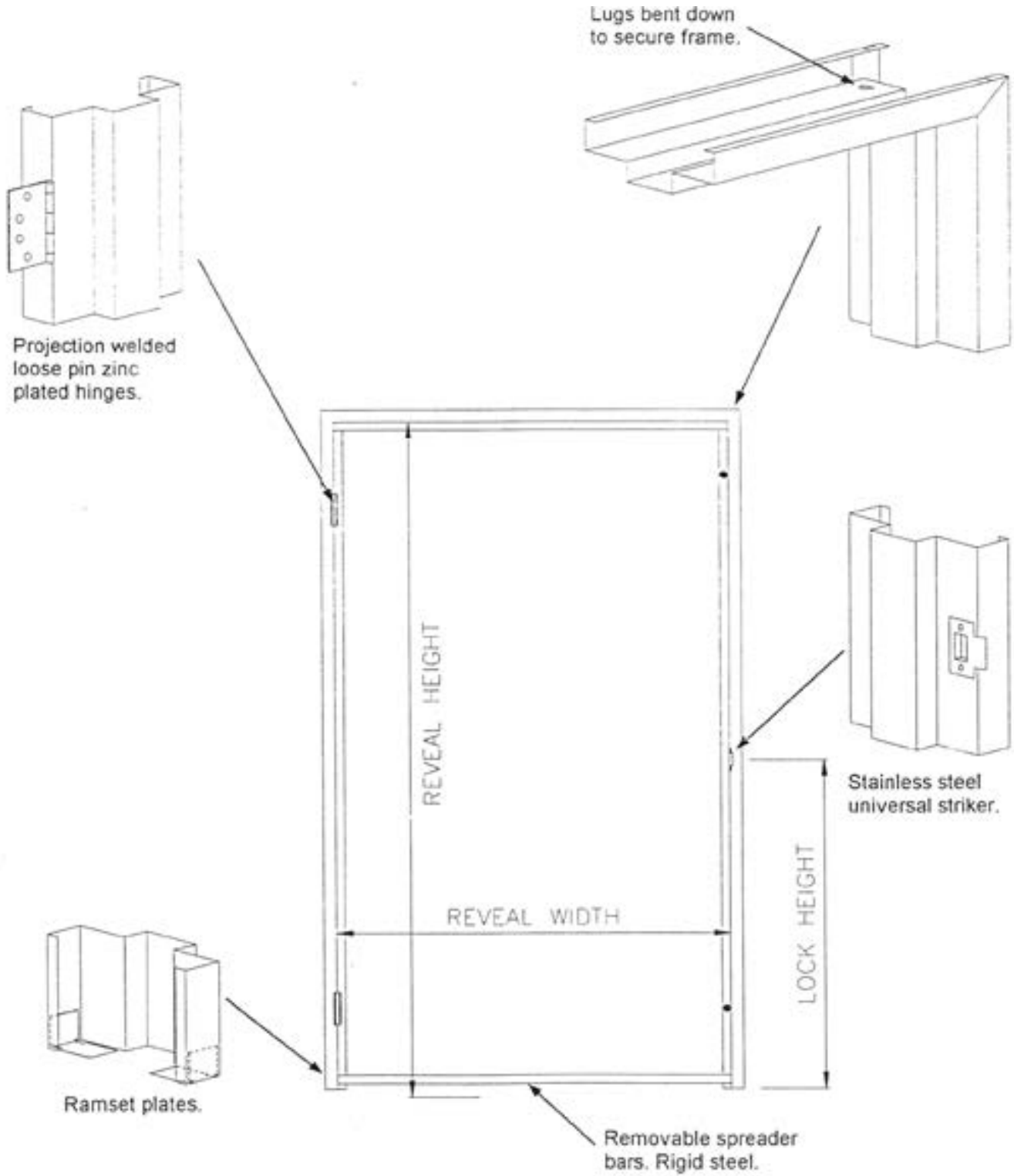

DOOR PRODUCTS

METAL DOOR FRAMES
KNOCK DOWN FRAMES

Knock down frames are supplied unassembled for ease of transportation. Individual wrapping (as shown) is optional.

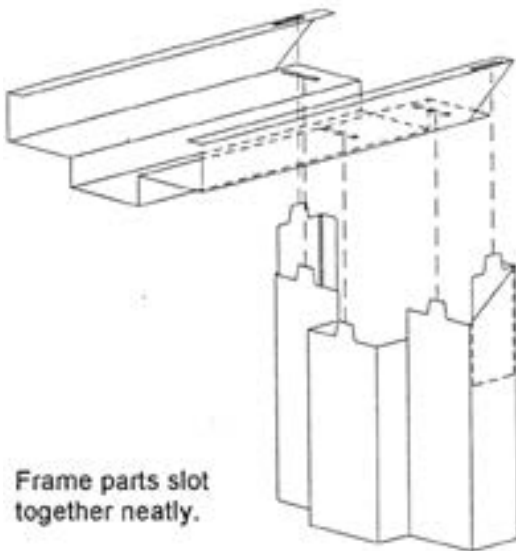

Frame parts slot together neatly.

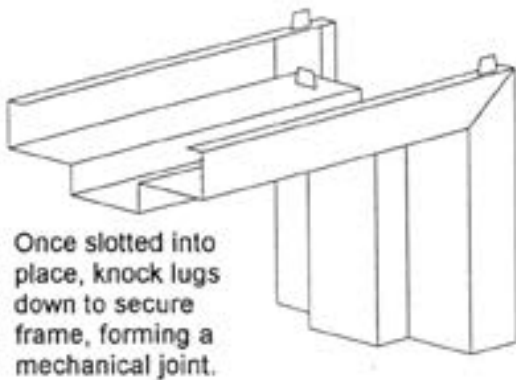

Once slotted into place, knock lugs down to secure frame, forming a mechanical joint.

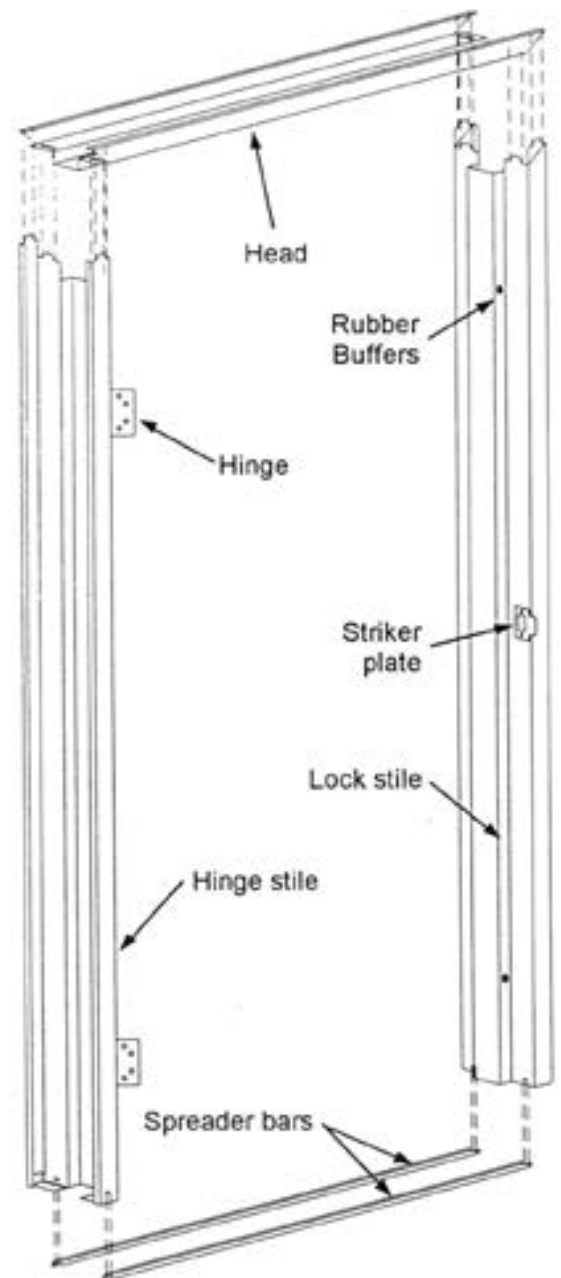

METAL DOOR FRAMES

STANDARD DOOR FRAMES FOR DRY WALLS

MASONRY FRAME WITH STUD CLIP FIXING

This is a method of fixing standard roll formed masonry frames into dry wall applications.

Suitable for use only in non-rated plasterboard partition walls.

Steel or timber studs may be used.

Frame throat size should be the same as the overall width of wall

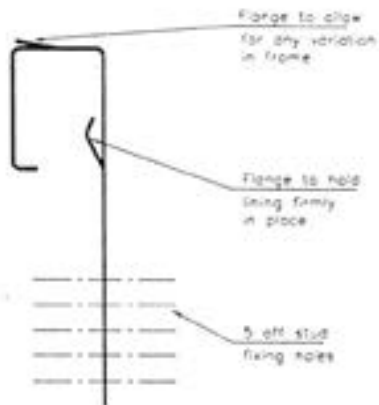

Stud clips are available to suit linings of 16mm, 13mm, 10mm and 6mm linings.

Other thicknesses available on request.

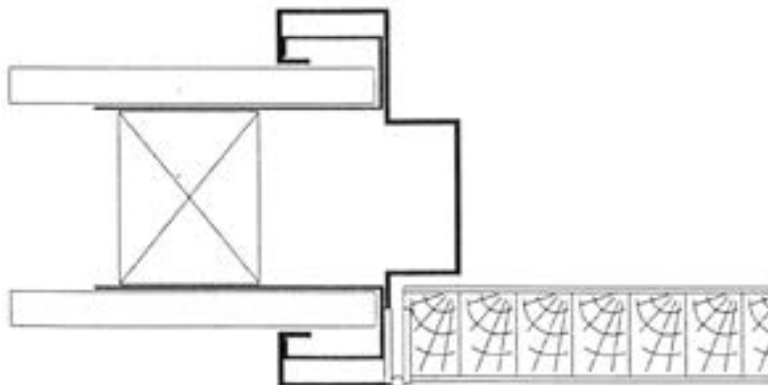
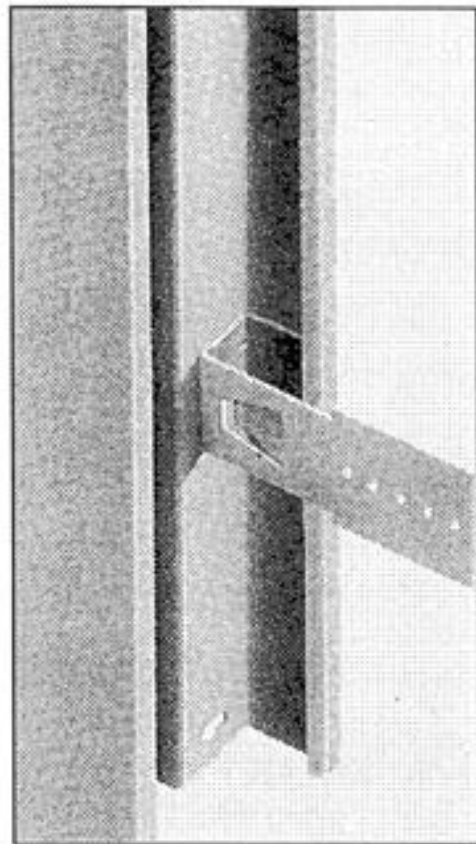

METAL DOOR FRAMES

STANDARD NON-RATED DOOR FRAMES

FRAME CODE
(STANDARD SIZES)
B (X)mm

DESCRIPTION

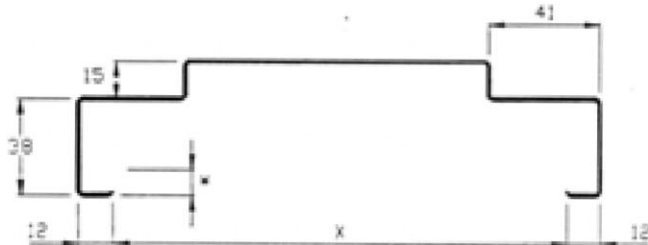

1.1mm zincanneal steel.
Rebate to suit doors 35mm thick.
Throat dimension 'X' is variable to suit wall thickness.
2 light duty loose pin zinc plated hinges.
1 universal striker.

- NR 86
- NR 93
- NR 102
- NR 114
- NR 123
- NR 145
- NR 194

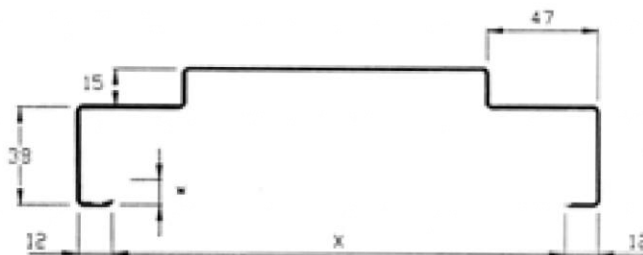

1.1mm zincanneal steel.
Rebate to suit doors 40mm thick.
Throat dimension 'X' is variable to suit wall thickness.
2 light duty loose pin zinc plated hinges.
1 universal striker.

- NRM 86
- NRM 93
- NRM 102
- NRM 114
- NRM 123
- NRM 145
- NRM 194

Brick & Block Work Walls

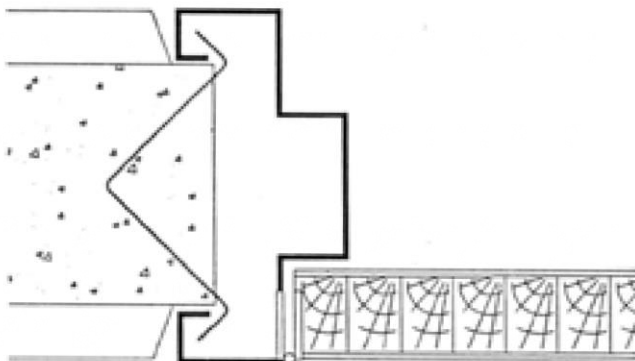

Concrete Walls & Retrofit Installation

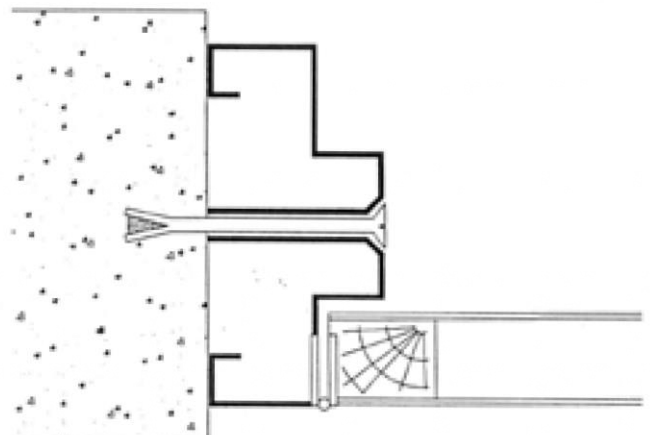

METAL DOOR FRAMES

SLIDING DOOR FRAMES

DESCRIPTION	FRAME CODE (STANDARD SIZES) SD (X)mm
	SD 114

1.1mm zincanneal steel.
Throat dimension 'X' is variable to suit wall thickness.



SD 93

1.1mm zincanneal steel.
Throat dimension 'X' is variable to suit wall thickness.

Brick & Block Work Walls

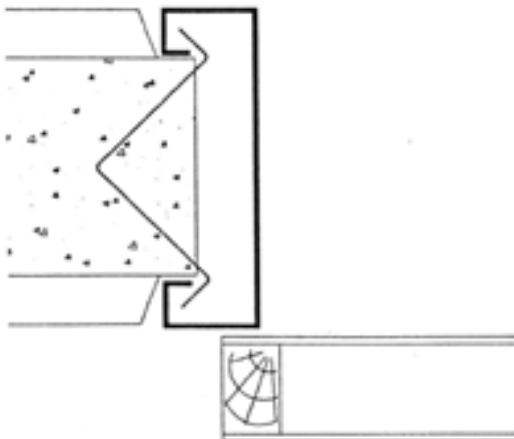

Concrete Walls & Retrofit Installation

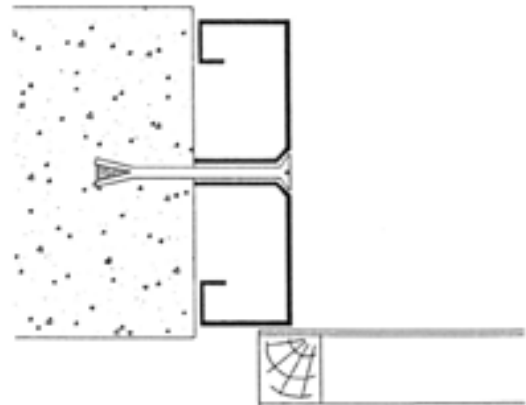

METAL DOOR FRAMES

NEW GENERATION DOOR FRAMES - INTERIOR

Suitable for stud wall applications

A unique designed frame for fast installation offering superior strength and clean finishing. (Patent pending).

DESCRIPTION

**FRAME CODE
(STANDARD SIZES)
B (X Z)mm**

Interior door frames

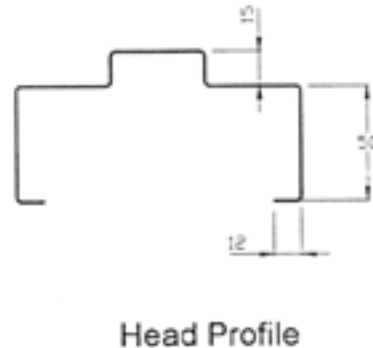
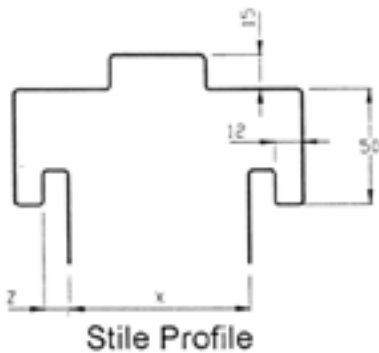

NR 76 10

NR 76 13

NR 92 10

NR 92 13

- 1.1mm zincanneal steel.
- Rebate to suit doors 35mm thick.
- Throat dimension 'X' is variable to suit wall thickness.
- Dimension 'Z' variable to suit plasterboard thickness.
- 2 light duty loose pin zinc plated hinges.
- 1 universal striker.

THREE STEPS TO EASY FITTING

Allow for stud opening size, add 90mm to door height and width eg;

2040mm x 820mm door
= stud opening of 2130mm x 910mm

Step 1.
Joggle assembled frame into existing stud opening.

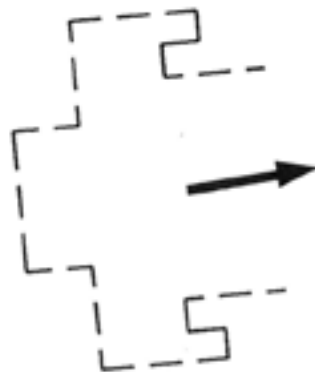

Step 2.
Fix leg of frame to studwork.

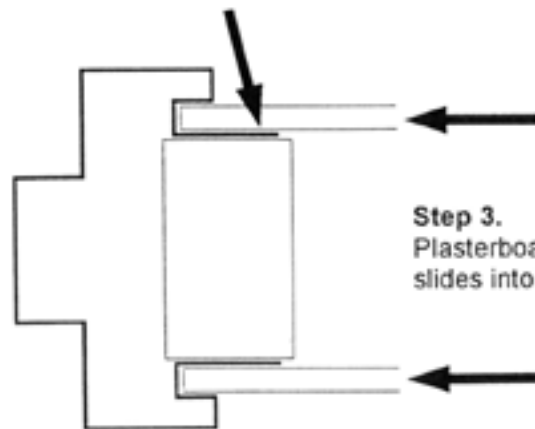

Step 3.
Plasterboard sheet slides into frame.



METAL DOOR FRAMES

NEW GENERATION DOOR FRAMES - EXTERIOR

Suitable for brick veneer applications

A unique designed frame for fast installation offering superior strength and clean finishing. (Patent pending).

DESCRIPTION

FRAME CODE
(STANDARD SIZES)

B (28 Z)mm

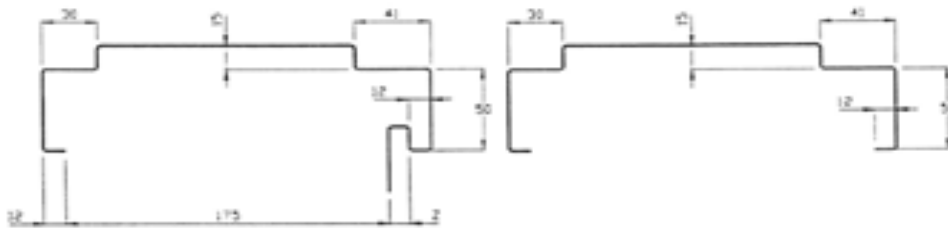

Stile Profile

Head Profile

1.1mm zincanneal steel.
 Rebate to suit doors 35mm thick.
 Dimension 'Z' variable to suit plasterboard thickness.
 2 light duty loose pin zinc plated hinges.
 1 universal striker.

NR 28 10
NR 28 13

The throat size may be changed to suit customers requirements provided it complies with the BCA

FOUR STEPS TO HIGHER SECURITY

Allow for stud opening size, add 90mm to door height and width eg;

2040mm x
 820mm door
 =
 stud opening of
 2130mm x
 910mm

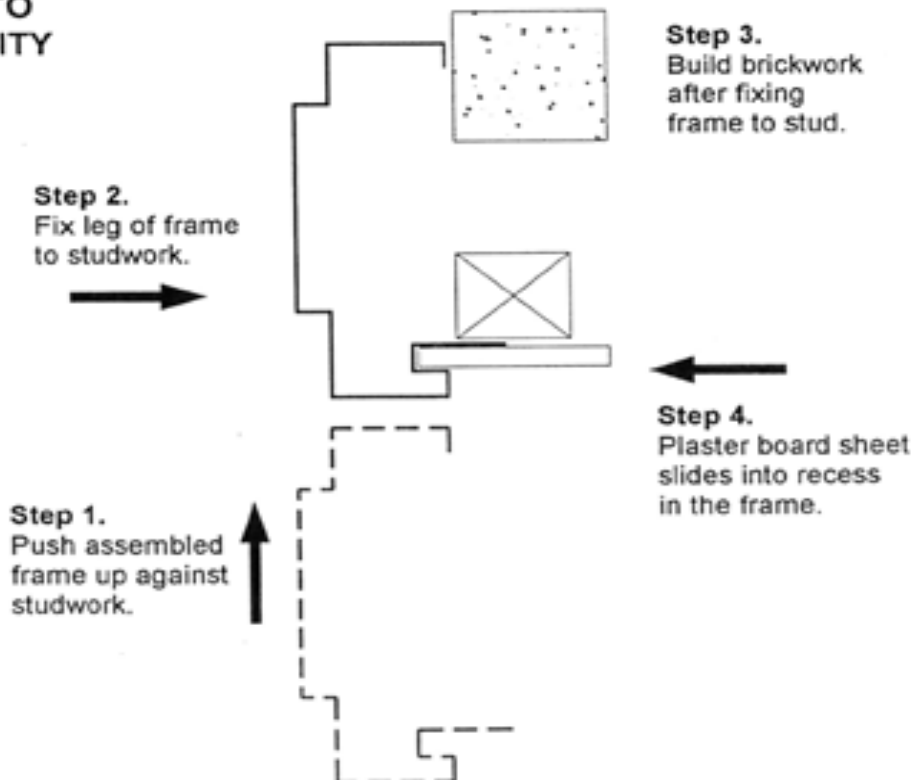

METAL DOOR FRAMES
FIRE DOOR FRAMES FOR MASONRY

DESCRIPTION

FRAME CODE
(STANDARD SIZES)
FR (X)mm

Maxi fire door frames:

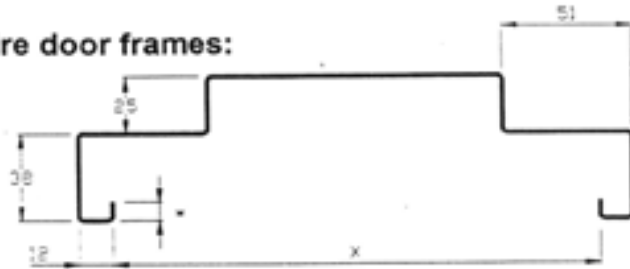

FR 114

FR 145

FR 193

1.4mm zincanneal steel.
 All frames fire tested up to four hours.
 Rebate to suit maxi fire doors 45mm thick.
 Throat dimension 'X' is variable to suit wall thickness.
 2 heavy duty loose pin zinc plated hinges.
 1 universal striker.

Mini fire door frames:

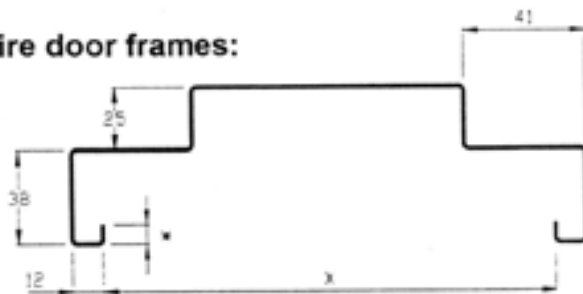

FRM 93

FRM 114

FRM 145

FRM 193

1.1mm zincanneal steel.
 All frames fire tested up to two hours.
 Rebate to suit mini fire doors 35mm thick.
 Throat dimension 'X' is variable to suit wall thickness.
 2 heavy duty loose pin zinc plated hinges.
 1 universal striker.

Brick & Block Work Walls

Frames must be grouted solid for fire ratings of over one hour.

Concrete Walls & Retrofit Installations

Frames must be grouted solid for all fire ratings.

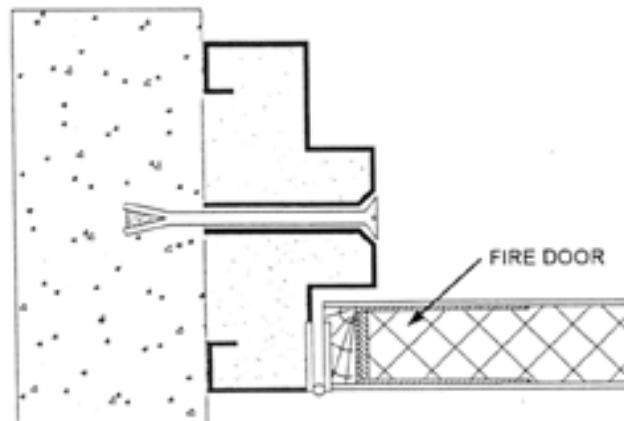
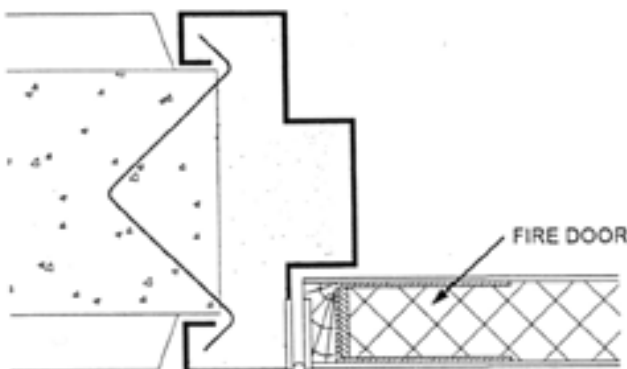

METAL DOOR FRAMES

FIRE DOOR FRAMES FOR DRY WALL - PARTITION FRAMES

DESCRIPTION

Maxi fire door frames:



1.4mm zincanneal steel.
 All frames fire tested up to three hours.
 Rebate to suit maxi fire doors 45mm thick.
 Throat dimension 'X' is variable to suit wall thickness.
 2 heavy duty loose pin zinc plated hinges.
 1 universal striker.

Mini fire door frames:

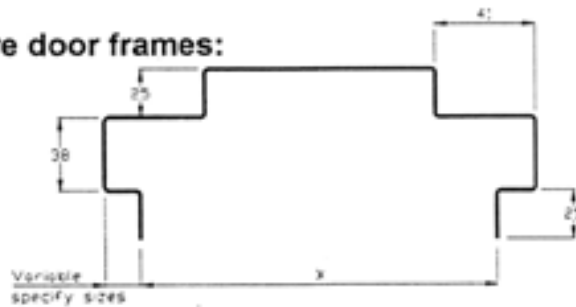

1.1mm zincanneal steel.
 All frames tested up to two hours.
 Rebate to suit mini fire doors 35mm thick.
 Throat dimension 'X' is variable to suit wall thickness.
 2 heavy duty loose pin zinc plated hinges.
 1 universal striker.

INSTALLATION:

One hour partition

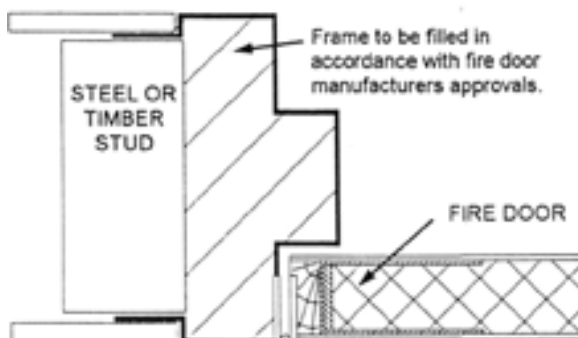

Two and three hour partitions

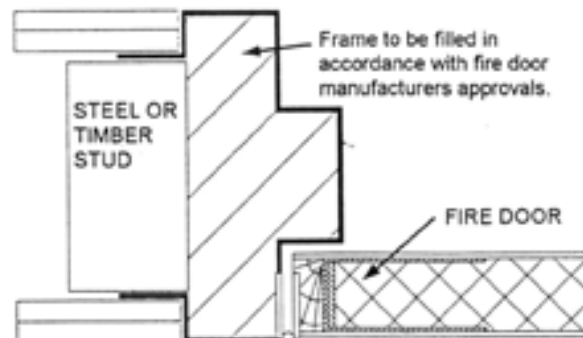

METAL DOOR FRAMES

FIRE DOOR FRAMES FOR DRY WALL

One Hour Partitions

Masonry frame with Fast Fix bracket.

DESCRIPTION

Maxi fire door frames:

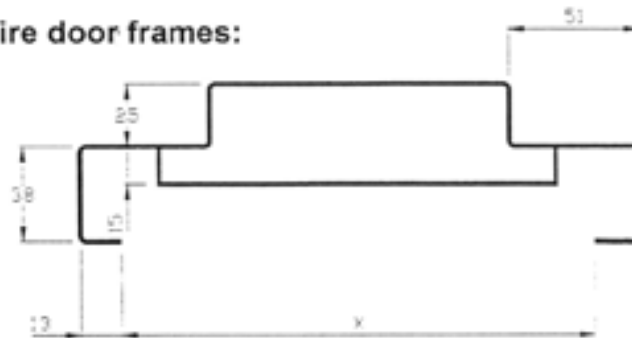

- 1.4mm zincanneal steel.
- All frames fire tested for one hour.
- Rebate to suit maxi fire doors 45mm thick.
- Throat dimension 'X' is variable to suit wall thickness.
- 2 heavy duty loose pin zinc plated hinges.
- 1 universal striker.

Mini fire door frames:

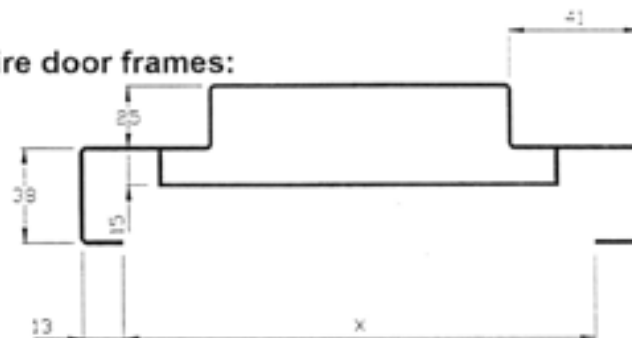

- 1.1mm zincanneal steel.
- All frames tested for one hour.
- Rebate to suit mini fire doors 35mm thick.
- Throat dimension 'X' is variable to suit wall thickness.
- 2 heavy duty loose pin zinc plated hinges.
- 1 universal sticker.

INSTALLATION:

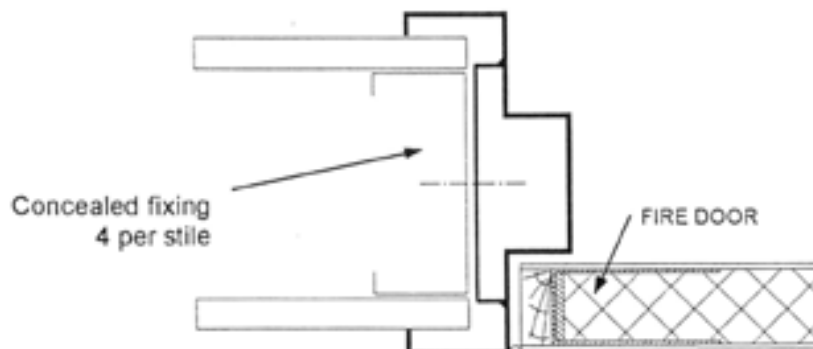

METAL DOOR FRAMES

FRAME FIXING DETAILS FOR MASONRY WALLS

BRICK AND BLOCK WORK WALLS

Standard roll formed frame.

Suitable for use in non-rated, one, two, three and four hour brick and block work walls.

Frame must be back filled for all fire ratings.

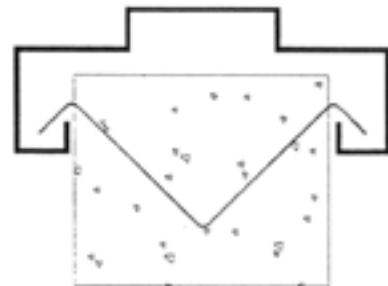

CONCRETE WALLS AND RETROFIT INSTALLATIONS

Standard roll formed frame.

Suitable for use in non-rated, one, two, three and four hour concrete and previously existing walls.

Frame must be back filled for all fire ratings.

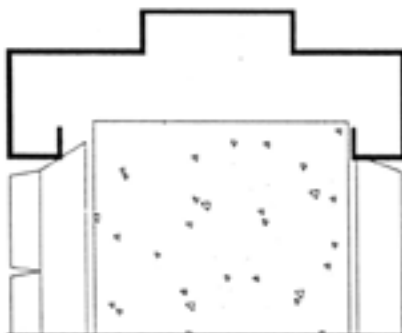
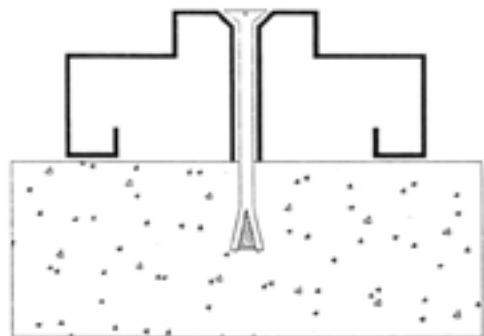

Render and tile application for brick using B123 frame profile.

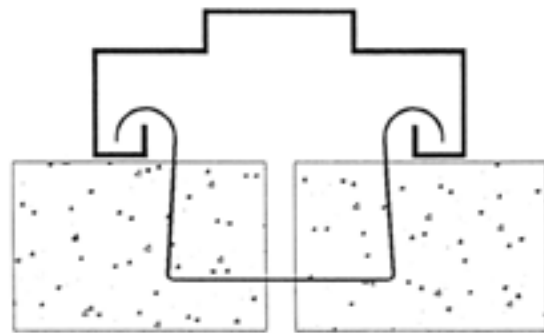

Double brick or block work

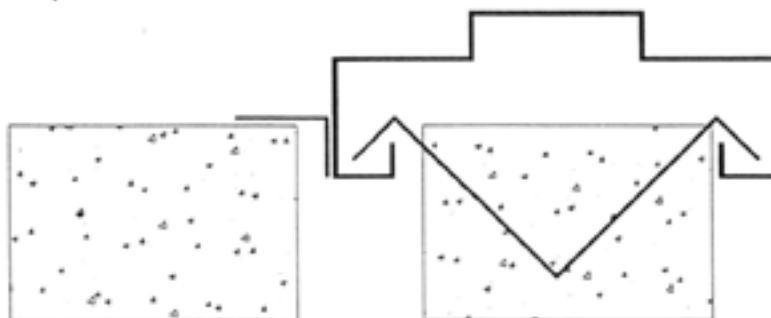

Cavity wall application using B146 profile with 30x19 weather mould.

METAL DOOR FRAMES

FRAME FIXING DETAILS FOR DRY WALLS

PARTITION DRY WALL FIRE DOOR FRAMES

This is the partition dry wall fire door frame, made by conventional brake press methodologies.

Suitable for use in one, two and three hour fire rated plasterboard partition walls.

Steel or timber studs may be used.

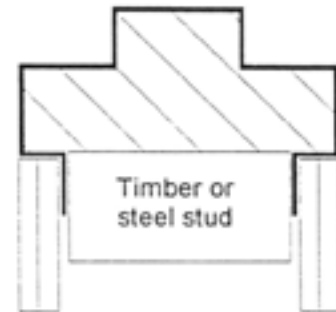

STANDARD FRAME WITH FAST FIX BRACKET

This is a new and innovative method for concealed of fixing standard roll formed masonry frames into dry wall applications.

Suitable for use in non-rated and one hour fire rated plasterboard partition walls.

Steel or timber studs may be used.

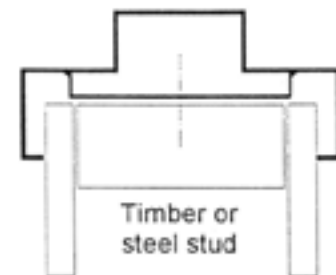

STANDARD FRAME WITH STUD CLIP FIXING

This is an innovative method of fixing standard roll formed masonry frames into dry wall applications.

Suitable for use only in non-rated partition walls.

Steel or timber studs may be used.

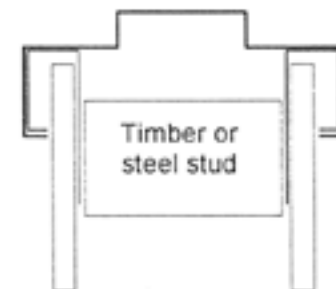

INTERIOR NEW GENERATION FRAMES

This new innovation allows plasterboard edges to be concealed with in the door frame.

Suitable for use only in non-rated partition walls.

Steel or timber studs may be used.

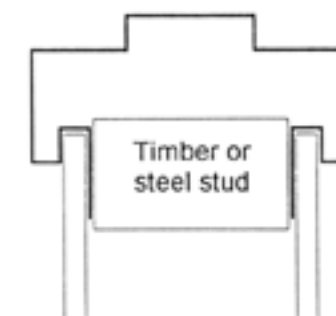

EXTERIOR RESIDENTIAL FRAMES FOR USE WITH BRICK VENEERS

This new innovation allows plasterboard edges to be concealed within the door frame.

Suitable for use only in non-rated exterior brick veneer partition walls.

Steel or timber studs may be used.

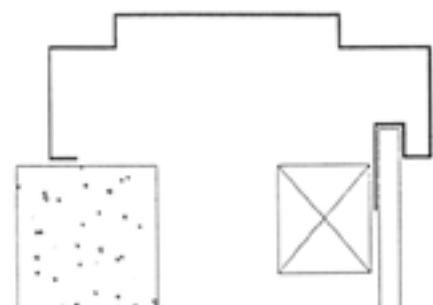

ACCESS DOORS SUBFLOOR

GALVANISED 725MM WIDTH X 434MM HEIGHT	GAD434	1
GALVANISED 725MM WIDTH X 520MM HEIGHT	GAD520	1
GALVANISED 725MM WIDTH X 692MM HEIGHT	GAD692	1
GALVANISED 725MM WIDTH X 863MM HEIGHT	GAD863	1
GALVANISED 725MM WIDTH X 1292MM HEIGHT	GAD1292	1

METAL DOOR FRAMES**DOOR FRAMES METAL KNOCKDOWN****STUD BRACKETS**

CLIPS TO SUIT 10MM PLASTER (16 PER PKT)BSTUD10	1
CLIPS TO SUIT 13MM PLASTER (16 PER PKT)BSTUD13	1
CLIPS TO SUIT 16MM PLASTER (16 PER PKT)BSTUD16	1
10 TYCO STANDARD WIRE TIES (PER 10)TWT	1
10 TYCO LARGE WIRE TIES (PER 10)TWTL	1
WIRE TIE FOR NEW GEN EXTERIORTWTSPEC1	1

THROAT SIZE 114MM DOUBLE D/FRAME HINGES X 3

ALL DOORS LISTED 41MM REBATES 1.1MM ZINC ANNEAL

DOUBLE DOOR - REVEAL SIZE 2055 X 1646 3 HINGE/STILEB11461646	1
DOUBLE DOOR - REVEAL SIZE 2055 X 1846 3 HINGE/STILEB11461846	1

THROAT SIZE 114MM LEFT HAND 3 HINGE - ASSEMBLED

ALL DOORS LISTED 41MM REBATES 1.1MM ZINC ANNEAL

REVEAL SIZE 2055 X 824 3 HINGE ASSEMBLEDB1143824LA	1
--	-------	-------	-------------	---

THROAT SIZE 114MM LEFT HAND 3 HINGE

ALL DOORS LISTED 41MM REBATES 1.1MM ZINC ANNEAL

REVEAL SIZE 2055 X 824B1143824L	1
REVEAL SIZE 2055 X1024B11431024L	1
REVEAL SIZE 2355 X 824B11432355824L	1
REVEAL SIZE 2055 X 924B1143924L	1

THROAT SIZE 114MM RIGHT HAND 3 HINGE - ASSEMBLED

ALL DOORS LISTED 41MM REBATES 1.1MM ZINC ANNEAL

REVEAL SIZE 2055 X 824 3 HINGE ASSEMBLEDB1143824RA	1
--	-----------	-----------	-------------	---

DOOR PRODUCTS

METAL DOOR FRAMES

THROAT SIZE 114MM RIGHT HAND 3 HINGE

ALL DOORS LISTED 41MM REBATES 1.1MM ZINC ANNEAL

REVEAL SIZE 2055 X 824	B1143824R	1
REVEAL SIZE 2055 X 924	B1143924R	1
REVEAL SIZE 2355 X 824	B11432355824R	1
REVEAL SIZE 2055 X1024	B11431024R	1

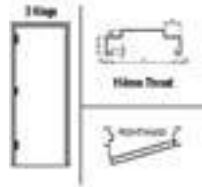
**THROAT SIZE 2810MM LEFT HAND 3 HINGE**

ALL DOORS LISTED 41MM REBATES 1.1MM ZINC ANNEAL

REVEAL SIZE 2065 X 824 (ASSEMBLED & WELDED)	B28103824LSPEC1	1
---	-----------------	---

THROAT SIZE 2810MM RIGHT HAND 3 HINGE

ALL DOORS LISTED 41MM REBATES 1.1MM ZINC ANNEAL

REVEAL SIZE 2065 X 824 (ASSEMBLED & WELDED)	B28103824RSPEC1	1
---	-----------------	---

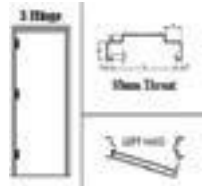
**THROAT SIZE 93MM LEFT HAND 3 HINGE**

B93 PROFILE IN 1.1MM ZINC ANNEAL 93MM THROAT REBATES 41MM X 15MM (SUIT 35MM THICK DOOR) HINGES WELDED STD STRICKER PREP ALL FRAMES KNOCKDOWN UNPRIMED

REVEAL SIZE 2055MM X 924MM	B933924L	1
--------------------------------------	----------	---

THROAT SIZE 93MM RIGHT HAND 3 HINGE

B93 PROFILE IN 1.1MM ZINC ANNEAL 93MM THROAT REBATES 41MM X 15MM (SUIT 35MM THICK DOOR) HINGES WELDED STD STRICKER PREP ALL FRAMES KNOCKDOWN UNPRIMED

REVEAL SIZE 2055MM X 924MM	B933924R	1
--------------------------------------	----------	---

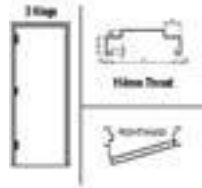
**FIRE RATED DOOR FRAMES****UP TO 2 HOUR RIGHT & LEFT HAND 3 HINGE - FULLY WELDED**

RATED UP TO 2 HOURS, 3 HINGES, 1.1MM ZINC ANNEAL, FULLY WELDED, DRESSED & PRIMED FOR BRICK / BLOCK INSTALLATION.

F114 R/H 2055 X 824 HINGE X 3	FR1143824RWDP	1
F114 L/H 2055 X 824 HINGE X 3	FR1143824LWDP	1

CONTACT OFFICE FOR PRICING ON PROJECT DOOR FRAMES, NON-FIRE RATED & FIRE RATED .

HB FULLER PRODUCTS

BUILDING FILLER	1
CAULK IN COLOURS	1
CAULKING GUNS	1
CONCRETE DISSOLVER	1
EASY CLEAR SILICONE SEALANT	2
EASY TILE CERAMIC ADHESIVE	2
EASY FILLER MULTIPURPOSE, HEAVY DUTY FILLER	2
FIRESOUND SEALANT	2
FLOOR BOND	2
FULAFOAM - MAXFILL EXPANDING FOAM	2
FULAPRENE 303 ADHESIVE SEALANT	2
FULAPRENE 550 - POLYURETHANE SEALANT	2
GAP FILLER	3
MAX BOND CONSTRUCTION ADHESIVE	3
MAX BOND FAST GRIP	3
MAX BOND P.V.A WOOD GLUE	3
MAX PRO SERIES	3
MAX PRO SERIES STARTER PACKS	3
RAPID GRIP CONTACT ADHESIVE - LIQUID	3
ROCOR RANGE	4
SILICONE - FULLER TRADE	4
SILICONE - FULLER TRADE 760 / 770 / 780	4
SILICONE - INDUSTRIAL GRADE	4
SILICONE - SEALANT 660	5
SPRAY BOND	5
SUPERSEAL HPR	5
TOOLBOX ADHESIVE SEALANT	5
ULTRA CLEAR	6
WPM 300 WATERPROOFING MEMBRANE	6



Description	Product Code	Box Qty
-------------	--------------	---------

BUILDING FILLER

BUILDING FILLER 500G HBF6025254084		8
BUILDING FILLER 1KG HBF6025254106		8
BUILDING FILLER 2KG HBF6025254013		4

CAULK IN COLOURS

BLACK 450G	HBF6003354112	6
BRILLIANT WHITE 450G	HBF7001734112	6
CEDAR 450G	HBF6003384112	6
CHARCOAL 450G	HBF6030974112	6
CREAM 450G	HBF6031104112	6
EARTH 450G	HBF6030934112	6
FAWN 450G	HBF6030994112	6
LIGHT GREY 450G	HBF6030924112	6
LIGHT IVORY 450G	HBF6008324112	6
MOCCA 450G	HBF6030954112	6
TERRACOTTA 450G	HBF6030964112	6
VANILLA 450G	HBF6003474112	6
WARM BROWN 450G	HBF6030944112	6
WHITE 450G	HBF6003484112	6



CAULKING GUNS

"EASY SQUEEZE" YELLOW C/GUN 300ML HBF6031499000		1
CAULKING GUN "TOUGH RED" HBF6075124094		1
CAULKING GUN "BIG RED" 856ML HBF6033124016		1
SAUSAGE BARRELL GUN (UNMODIFIED) 600ML HBF6018714151		1



Description	Product Code	Box Qty
EASY CLEAR SILICONE SEALANT		
EASY CLEAR 270G	HBF6034554048	6
EASY TILE CERAMIC ADHESIVE		
EASY TILE 500ML	HBF6030454021	12
EASY TILE 1LT	HBF6030454105	12
EASY TILE 4LT	HBF6030454020	1
EASY FILLER MULTIPURPOSE, HEAVY DUTY FILLER		
MULTI PURPOSE, HEAVY DUTY, PREMIX 260G	HBF4147014238	12
MULTI PURPOSE, HEAVY DUTY, PREMIX 600G	HBF6031224137	12
MULTI PURPOSE, HEAVY DUTY, PREMIX 1 5KG	HBF4147014239	6
ECONOMY SILICONES		
PLUMBING SILICONE TRANS 300G	HBF6004494224	20
FIRESOUND SEALANT		
FIRESOUND FIRE RATED ACOUSTIC SEALANT - GREY 450G	HBF6025914042	20
FIRESOUND FIRE RATED ACOUSTIC SEALANT - GREY 10LT	HBF6011741513	1
FLOOR BOND		
FLOOR BOND MS PAIL 16KG	HBF7026901513	1
FULAFOAM - MAXFILL EXPANDING FOAM		
FULAFOAM - MAXFILL EXPANDING 300ML	HBF7031334161	12
FULAFOAM - MAXFILL EXPANDING 500ML	HBF7031334084	12
FULAFOAM - MAXFILL EXPANDING 750ML	HBF7031334007	12
FULAFOAM - FIRE RETARDENT FOAM 500G	HBF7011954084	12
FULAFOAM PRO - GUN FOAM 750ML	HBF7068444161	12
FULAPRENE 303 ADHESIVE SEALANT		
FULAPRENE 303 300G	HBF6003894033	20
FULAFLEX 550 - POLYURETHANE SEALANT - SAUSAGE		
FULAFLEX BLACK 600ML	HBF7156674237	20
FULAFLEX WHITE 600ML	HBF7156684237	20
FULAFLEX GREY 600ML	HBF7156704237	20



HB FULLER PRODUCTS

Description	Product Code	Box Qty
-------------	--------------	---------

GAP FILLER

WHITE 450G	HBF6003954042	20
------------	---------------	----

MAX BOND CONSTRUCTION ADHESIVE

MAX BOND BUCKET 320G X 20 HBF4146264094		1
MAX BOND SAUSAGE 600ML HBF6004134133		15

MAX BOND FAST GRIP

FAST GRIP - CARTRIDGE 420G HBF6020684010		20
FAST GRIP - FLOORING CONCORDE 1 5KG HBF6025984134		10
FAST GRIP - SAUSAGE 600ML HBF4145534133		15

MAX BOND P.V.A WOOD GLUE

MAX BOND PVA 250ML HBF6004924019		15
MAX BOND PVA 500ML HBF6004924021		12
MAX BOND PVA 1LT HBF6004924018		6
MAX BOND PVA 5LT HBF6004924022		1

**MAX PRO SERIES**

MAX BOND PRO 680G HBF7319644238		12
MAX PRO CLEANER 340G HBF7319624110		12
ECONOMY FOAM GUN 505 HBF6035474365		1

MAX PRO SERIES STARTER PACKS

MAX BOND PRO ECONOMY STARTER PACK 1 7KG CONTAINS: MAX BOND PRO 680G X 2, ECONOMY FOAM GUN X 2	HBF7319644252	1
--	---------------	---

RAPID GRIP CONTACT ADHESIVE - LIQUID

RAPID GRIP - LIQUID 1LT HBF6004214012		6
RAPID GRIP - LIQUID 4LT HBF6004214020		1

Description	Product Code	Box Qty
-------------	--------------	---------

ROCOR RANGE

STUD ADHESIVE - GREEN TRADE 5 2KG	HBF6025061520	1
-----------------------------------	---------------	---

SILICONE - FULLER TRADE

790 MIRROR METAL - TRANS 300G	HBF6009264033	20
ROOF, GUTTER & CONCRETE - GREY 400G	HBF6004504033	20
ROOF, GUTTER & CONCRETE - TRANS 300G	HBF6004524033	20
ROOF, GUTTER & CONCRETE - BLACK 300G	HBF6004484033	20
WINDOW & GLASS - CLEAR 300G	HBF6004464033	20
BATHROOM & KITCHEN - CLEAR 300G	HBF6004444033	20
BATHROOM & KITCHEN - WHITE 300G	HBF6004454033	20
MULTI-PURPOSE - TRANSLUCENT 300G	HBF6004534033	20
PAINTABLE SILICONE 720 - WHITE 400G	HBF7330544245	12
PLUMBING SILICONE - TRANSLUCENT 300G	HBF6004484224	20
WET AREA PLUMBING SILICONE - WHITE 300G	HBF6009104220	20
WET AREA PLUMBING SILICONE - TRANS 300G	HBF6009104220	20
FULLER TRADE GAP FILLER 450G	HBF6033734042	20
FULLER TRADE CONSTRUCTION ADHESIVE 300G	HBF6033724011	20

SILICONE - FULLER TRADE 760 / 770 / 780

760 GLAZING SILICONE - MATT BLACK 400G HBF7318694220		20
780 PLUMBERS SILICONE - TRANS 300G HBF6009014033		20
780 PLUMBERS SILICONE - GREY 400G HBF6009024119		20
780 PLUMBERS SILICONE - ALUMINIUM 300G HBF7024544033		20
770 SANITARY - WHITE 300G HBF6009104033		20
770 SANITARY - MID GREY 300G HBF7363134164		12
770 SANITARY - TRANSLUCENT 300G HBF6009014286		20
770 SANITARY - TILE GREY HBF7056074164		12
770 SANITARY - ALMOND IVORY HBF7056084164		12

SILICONE - INDUSTRIAL GRADE

HBF 730 INDUSTRIAL SILICONE - TRANS 300G HBF7056094164		12
HBF 730 INDUSTRIAL SILICONE - BLACK 300G HBF7056104164		12
HBF 260 HIGH TEMPERATURE SILICONE 300G HBF7057194189		12

Description	Product Code	Box Qty
SILICONE - SEALANT 660		
660 HI PERFORMANCE SILICONE/SEALANT BLACK 300G HBF7060924164		12
660 HI PERFORMANCE SILICONE/SEALANT TRANS 300G HBF7060914164		12
620 HI PERFORMANCE GLAZING SILICONE TRANS 300G HBF7056094221		12
SPRAY BOND		
SPRAY BOND - PERMANENT 350G	HBF6004544056	12
SUPERSEAL		
SUPERSEAL HPR 650FC - GREY 420G HBF7329594410		12
SUPERSEAL HPR 50FC - WHITE 420G HBF7331764250		12
SUPERSEAL HPR 25 - BLACK 400G HBF7330554250		12
SUPERSEAL HPR 25 - GREY 400G HBF7329604250		12
SUPERSEAL HPR 25 - WHITE 400G HBF7330544250		12
TOOLBOX ADHESIVE SEALANT		
TOOLBOX ADH/SEALANT - GREY 400G HBF7029774250		12
TOOLBOX ADH/SEALANT - WHITE 400G HBF7029764250		12
TOOLBOX ADH/SEALANT - BLACK 400G HBF7063564250		12
TOOLBOX ADH/SEALANT - SAUSAGE WHITE 500ML HBF7052624237		20
ULTRA CLEAR		
ULTRA CLEAR - CARTRIDGE 300G	HBF6012974042	20



DRAINAGE & GRATINGS

ACO DRAINS	1
GEOTEXTILE FILTER FABRIC	1
GRATING - STEEL FRAME	1
GRATING - STEEL GRATE	1
PITS & GRATES	1
PLASTIC U CHANNELS	2
PRO DRAIN	2
SILT FENCE	2
STORMWATER FITTINGS 100MM	2
STORMWATER FITTINGS 90MM	3
STORMWATER PIPE	3
SUB SOIL PIPE	4

D

DRAINAGE & GRATINGS

Description	Product Code	Box Qty
-------------	--------------	---------

ACO DRAINS**ULTIMATE 100**

1MTR POLYMER CONCRETE WITH GALV GRATE ACO70442

1

POLYMER CONCRETE END CAP ACO78158

1

ULTIMATE 200

1MTR POLYMER CONCRETE WITH GALV GRATE ACO3612

1

POLYMER CONCRETE END CAP ACO3697

1

**GEOTEXTILE FILTER FABRIC**

FILTER GRADE FABRIC 1MTR X 50MTR TEN1

1

FILTER GRADE FABRIC 2MTR X 50MTR TEN2

1

**GRATING - STEEL FRAME**

STEEL FRAME 235 X 235 L/D GALV GF230GAL

1

STEEL FRAME 305 X 305 L/D GALV GF300GAL

1

STEEL FRAME 385 X 385 L/D GALV GF380GAL

1

STEEL FRAME 460 X 460 L/D GALV GF455GAL

1

STEEL FRAME 605 X 605 L/D GALV GF600GAL

1

**GRATING - STEEL GRATE**

STEEL GRATE 230MM X 230MM L/D GALV

G230GAL

1

STEEL GRATE 300MM X 300MM L/D GALV

G300GAL

1

STEEL GRATE 380MM X 380MM L/D GALV

G380GAL

1

STEEL GRATE 455MM X 455MM L/D GALV

G455GAL

1

STEEL GRATE 600MM X 600MM L/D GALV

G600GAL

1

**PITS & GRATES**

PIT & GRATE BLACK 200MM (225MM X 225MM X 280MM EXTERNAL) GAP200

1

PIT & GRATE BLACK 300MM (310MM X 310MM X 405MM EXTERNAL) GAP300

1

PLASTIC PIT W450 X W450 X 600D WITH L/D STEEL GRATE GAP450LD

1

GRATE ONLY BLACK PLASTIC ALLSTORM 220MM GRAT2

1

GRATE ONLY PLASTIC ALLSTORM 300MM GRAT3

1

RELN UNI PIT WITH PLASTIC GRATE BLACK (230MM X 230MM X 80MM) R002240

1

RELN UNI PIT WITH PLAIN ALUMINIUM GRATE (230MM X 230MM X 80MM) R002241

1



Description	Product Code	Box Qty
TYPE 22 PLASTIC PIT WITH ALUM GRATE 220WX220WX250D	ACO70392	1
TYPE 33 PLASTIC PIT & ALUM GRATE 300WX300WX370D	ACO70404	1
ICON ICON DRAINAWAY 90 DEGREE BEND PLASTIC GRATE	ICON14	4



PLASTIC U CHANNELS

ICON PLASTICS

CHANNEL & STAINLESS STEEL GRATE 1MTR (PALLET 64)	ICON1SS	1
CHANNEL & STAINLESS STEEL GRATE 3MTR (PALLET 48)	ICON3SS	1
STRAIGHT JOINER BLACK	ICON4	1
END OUTLET 90/100MM	ICON5	1
VERTICAL DROPPER	ICON7	1



RELN

U CHANNEL 3MTR WITH BLACK PLASTIC GRATE	R001324	2
U CHANNEL 1MTR WITH BLACK PLASTIC GRATE	R001133	2
RAIN DRAIN GRATE 3MTR GALVANISED GRATE	R001334	2
RAIN DRAIN SLOTTED GRATE 1MTR GALVANISED GRATE	R001143	2



RELN ACCESSORIES

RAIN DRAIN JOINER	R001157	1
RAIN DRAIN END CAP	R001164	1
RAIN DRAIN 90 DEGREE CORNER BLACK PLASTIC	R002480	1

PRO DRAIN

VERTICAL DRAIN FOR RETAINING WALL

PRO DRAIN CD12MM CORE 1MTR X 25MTR	TEN13	1
------------------------------------	-------	---

SILT FENCE

SILT FENCE STD GRADE GREEN UV 0 86MTR X 100MTR	TEN5A	1
--	-------	---



STORMWATER FITTINGS 100MM

FITTINGS 100MM

PRICES ON PVC MAY CHANGE AND WE SUGGEST YOU TO CONTACT OUR OFFICE FOR CURRENT COSTS.

PLAIN BEND F & F 15° SWV15	35
PLAIN BEND F & F 30° SWV30	35
PLAIN BEND F & F 45° SWV45	32
PLAIN BEND F & F 88° SWV90	25
JUNCTION 45° (Y) F & F SWVY	15



DRAINAGE & GRATINGS

Description	Product Code	Box Qty
TEE JUNCTION 27A SWVTEE100		20
SLAB REPAIR COUPLING 1 PIECE SWVRC		45
REPAIR COUPLING 2 PIECE SWVRC100		50
FINISHING COLLAR & GRATE 100MM SWFC100		100
PUSH ON CAP SWVCAP		48
THREADED COUPLING SWVTC		56



STORMWATER FITTINGS 90MM

FITTINGS 90MM

PRICES ON PVC MAY CHANGE AND WE SUGGEST YOU TO CONTACT OUR OFFICE FOR CURRENT COSTS.

BENDS 15 X 90MM	SWB15	110
BENDS 22 X 90MM	SWB22	100
BENDS 45 X 90MM	SWB45	80
BENDS 90 X 90MM	SWB90	60
Y JUNCTION	SWY	30
T JUNCTION	SWT	30
JOINER/SLIP REPAIR COUPLING	SWRC	150
FINISHING COLLAR & GRATE 90MM	SWFC	100
PUSH ON CAP	SWCAP	300
THREADED CAP	SWCAPT	110
DOWNPIPE ADAPTOR 100 X 50MM	SWDP	150
DOWNPIPE ADAPTOR 100 X 80MM	SWDPL	80
THREADED COUPLING	SWTC	80
90-40MM STEP REDUCER	SWR	200
100-90MM ADAPTOR "BUSH TYPE"	SWR100	100
SQUARE GRATE	SWSG	160



STORMWATER PIPE

PIPE 100MM (DWV) (CAN BE MIXED WITH 90MM PIPE)

DIRECT DELIVERY ONLY MELBOURNE METRO

PRICES ON PVC MAY CHANGE AND WE SUGGEST YOU TO CONTACT OUR OFFICE FOR CURRENT COSTS.

100MM PIPE DWV FOAM CORE SN6 SCJ 6MTR (MIN 30 LENGTHS) DWV100	30
---	----

PIPE 90MM - FULL PACKS

MINIMUM ORDER - 50 LENGTHS (CAN BE MIXED) FULL PACKS = 72 LENGTHS

PREMIUM WHITE STORMWATER PIPE 90MM X 6MTR SWPPKPREM	72
SW SLOTTED 90MM X 6MTR SWSPK	72



Description	Product Code	Box Qty
SUB SOIL PIPE		
SUB SOIL DRAINAGE PIPE		
50MM X 10MTR SUB SOIL PIPE	FP5010	1
50MM X 20MTR SUB SOIL PIPE	FP5020	1
65MM X 10MTR SUB SOIL PIPE	FP6510	1
65MM X 20MTR SUB SOIL PIPE	FP6520	1
80MM X 20MTR SUB SOIL PIPE	FP8020	1
100MM X 10MTR SUB SOIL PIPE	FP10010	1
100MM X 20MTR SUB SOIL PIPE	FP10020	1
100MM X 100MTR SUB SOIL PIPE	FP100100	1
SUB SOIL DRAINAGE PIPE - FILTER SOCK		
50MM X 20MTR WITH SOCK SUB SOIL PIPE	FP5020FS	1
65MM X 20MTR WITH SOCK SUB SOIL PIPE	FP6520FS	1
80MM X 20MTR WITH SOCK SUB SOIL PIPE	FP8020FS	1
100MM X 20MTR WITH SOCK SUB SOIL PIPE	FP10020FS	1
100MM X 100MTR WITH SOCK SUB SOIL PIPE	FP100100FS	1

GARDEN PRODUCTS

ANT, ROACH & SPIDER KILLERS	1	TREE AND BLACKBERRY KILLER	12
BAMBOO STAKES	1	TREE KILLER	12
PROTECTION	1	TREE STAC	13
BLOOD & BONE	1	TREE TIES	13
CARBARYL	1	VEGETABLE DUST	13
CONTROLLED RELEASE FERTILISER	2	WASP NEST DESTROYER	13
DYNAMIC LIFTER	2	WATERING CANS	13
ECO - ORGANIC CROP PROTECTANT	3	WEED AND FEED	13
FERTILIZERS	3	WEED KILLER	13
FUNGICIDE	4	WEEDMASTER 360	13
GARDEN EDGING PEGS - METAL	4	WEEDMATS (GROUND COVERS)	14
GARDEN EDGING PEGS - PLASTIC	4	WEEDMAT ACCESSORIES	14
GARDEN EDGING PLASTIC	4	WETTING AGENTS	14
GARDEN EDGING STEEL	5	WHITE OIL - INSECTICIDE	14
GARDEN EDGING TIMBER	5	WOODEN PEGS	14
GARDEN LIME	5	ZERO WEEDSPRAY	15
GYPHOSUM	5		
HESSIAN BAGS	5		
HESSIAN TREE TIE	5		
HYDRANGEA BLUEING	5		
INSECT TRAP	6		
JOLLY TIES	6		
LAWN FERTILIZER	6		
LAWN GRUB KILLER	6		
LAWN SEEDS	6		
LAWN STARTER	7		
LEAF CURL COPPER FUNGICIDE SPRAY	7		
LIME SULPHUR	8		
MALATHION	8		
MANCOZEB PLUS	8		
MANURE	8		
MARKER DYE	8		
MAVRIK	8		
NO GROW 500 GLYPHOSATE	8		
ORCHID FOOD	8		
ORCHID POTTING MIX	8		
PATHWEEDER	8		
PEATMOSS	9		
PEST OIL	9		
PLANT STARTER	9		
PYRETHRUM	9		
RAT & MICE KILL - BAIT & TRAPS	9		
ROOTEX	10		
ROSE BLACK SPOT	10		
ROSE GUN - INSECTICIDE	10		
ROUNDUP	10		
SAND AND SOIL BAGS	10		
SCALE GUN	10		
SEED RAISING MIX	10		
SNAIL AND SLUG	10		
SPRAYERS	11		
SUGAR CANE MULCH	11		
SULPHATE OF AMMONIA	11		
LIQUID POTASH	12		
TIMBER STAKES	12		

GARDEN PRODUCTS

Description	Product Code	Box Qty
-------------	--------------	---------

ANT, ROACH & SPIDER KILLERS

TERMINANT ANT KILLER SPRAY 250ML CRG0080		12
BAYER ADVANCE ANT & WASP DUST 350G PUFFER Y50205		6
AQUASOL HORTICO AQUASOL 600G Y50726		6

**BAMBOO STAKES**

BULK BAMBOO STAKES 90CM 10-12MM (250 PER BOX) NATURAL	SUN92	1
---	-------	---

BLOOD & BONE

YATES BLOOD AND BONE BASED 5KG Y51395		3
YATES BLOOD AND BONE BASED 10KG Y51396		1
YATES BLOOD AND BONE BASED 15KG Y51523		1

CARBARYL

HEINIGER LIQUID CARBARYL 500ML	CRG0130	6
--------------------------------	---------	---

CONTROLLED RELEASE FERTILIZER

OSMOCOTE POTS, PLANTERS & INDOOR 500G	SCOT3287	6
POTS, PLANTERS & INDOOR 1KG	SCOT3423	6
POTS, PLANTERS & INDOOR 2KG	SCOT3485	4
FRUIT, CITRUS, TREES & SHRUBS 500G	SCOT3294	6
FRUIT, CITRUS, TREES & SHRUBS 1KG	SCOT3430	6
FRUIT, CITRUS, TREES & SHRUBS 2KG	SCOT3492	4
NATIVES 500G	SCOT3324	6
NATIVES 1KG	SCOT3461	6
NATIVES 2KG	SCOT3522	4
VEGETABLE, TOMATO, HERB & GARDEN BED 500G	SCOT3300	6
VEGETABLE, TOMATO, HERB & GARDEN BED 1KG	SCOT3447	6
VEGETABLE, TOMATO, HERB & GARDEN BED 2KG	SCOT3508	4
ROSE, GARDENIAS, AZALEAS/CAMELIAS 500G	SCOT3331	6
ROSE, GARDENIAS, AZALEAS/CAMELIAS 1KG	SCOT3478	6
ALL PURPOSE TOTAL 1KG	SCOT3454	6
ALL PURPOSE TOTAL 500G	SCOT3317	6



Description	Product Code	Box Qty
-------------	--------------	---------

DYNAMIC LIFTER**DYNAMIC LIFTER PLANT FOOD**

DYMANIC LIFTER PLANT FOOD 7KG Y52907		1
DYNAMIC LIFTER PLANT FOOD 15KG Y52909		1
DYNAMIC LIFTER 2 5KG Y52903		4
DYNAMIC LIFTER 35KG (FULL PALLETS ONLY) Y41648		32

ECO - ORGANIC CROP PROTECTANT

ECO OIL HIPPO 500ML Y55624		10
ECO FLOW GYPSUM 500ML Y55641		10
ECO FLOW GYPSUM 2LTR HOSE ON Y55643		4
ECO NEM 100ML Y55616		10

FERTILIZERS

ALL PURPOSE SOLUBLE THRIVE 500G - YATES	Y50730	6
AZALEA/CAMELLIA FOOD 2 5KG - MAXICROP BRUNNINGS	MAX40480	6
COMPLETE GARDEN FOOD BRUNNINGS 2 5KG - MAXICROP	MAX40850	6
FRUIT & CITRUS FOOD BRUNNINGS 2 5KG - MAXICROP	MAX41100	6
ROSE FOOD BRUNNINGS 2 5KG - MAXICROP	MAX42372	6
SEASOL 500ML CONCENTRATE	S230031	12
SEASOL 1 LTR CONCENTRATE	S230048	12
SEASOL 2 LTR CONCENTRATE	S231328	4
SEASOL 4 LTR CONCENTRATE	S230161	4
SEASOL 8LTR CONCENTRATE	S232202	1
SEASOL 2 5 LTR RTU HOSE ON	S210677	4
POWERFEED 500ML	S230208	12
POWERFEED 1 LTR	S230307	12
POWERFEED 2LTR	S231335	4
POWERFEED 2 5 LTR	S230888	4
POWERFEED 2 5 LTR RTU HOSE ON	S210678	4
SEASOL / POWERFEED BLEND 2LTR HOSE ON	S210700	4



GARDEN PRODUCTS

Description	Product Code	Box Qty
POWERFEED 4 LTR	S230482	2
POWERFEED 2 LTR HOSE ON	S230284	4
POWERFEED 8 LTR	S232219	1
SEASOL NURSERY PACK (2L RTU & 500ML)	S230505	4
SEASOL 750ML RTU FOLIAR SPRAY	S230628	4
SEASOL FOR LUSH LAWNS 2 LTR HOSE ON	S230642	4
POWERFEED 2.5 LTR BOTTLE	S230888	4
SEASOL PLANTING GEL 800GM	S230864	12
SEASOL POWERFEED FOR VEG CONC 500ML	S230956	12
SEASOL POWERFEED FOR VEG CONC 1 LTR	S230605	12

**FUNGICIDE**

30 G KOCIDE BLUE FUNGICIDE MAX91315		6
FUNGUS GUN RTU 750ML Y52194		6
LIQUID COPPER FUNGICIDE 200ML Y53851		6

**GARDEN EDGING PEGS - METAL**

JARRAH HOLD DOWN PEGS 20MM (100) MATTE JP1		1
JARRAH HOLD DOWN PEGS 20MM (100) GLOSS JP1A		1
JARRAH HOLD DOWN PEGS 40MM (50) MATTE JP2		1
JARRAH HOLD DOWN PEGS 40MM (50) GLOSS JP2A		1

**GARDEN EDGING PEGS - PLASTIC**

FAIRBANKS LAWN EDGE PEGS JARRAH 290MM (BOX 50)	FGEPEGJ	1
--	---------	---

**GARDEN EDGING PLASTIC**

FAIRBANKS JARRAH LAWN EDGE 100MM X 10MTR FGE10010J		1
JARRAH LAWN EDGE 75MM X 10MTR FGE7510J		1
JARRAH PLASTIC EDGING JARRAH 75MM X 8MM X 4 2MTR FGE7542		100
ENVIRO GARDEN EDGE 75MM X 8MM X 4 2MTR FGE7542ENVIRO		100

**GARDEN EDGING STEEL**

2 4MTR X 75MM STEEL GARDEN EDGING FGESTEEL		1
100MM X 75MM STEEL GARDEN EDGING JOINER FGESTEELJOINER		1

Description	Product Code	Box Qty
-------------	--------------	---------

GARDEN EDGING TIMBER

 4 2MTR HARDWOOD GARDEN EDGING JWP42		224
4 5MTR HARDWOOD GARDEN EDGING JWP45		224
4 8MTR HARDWOOD GARDEN EDGING JWP48		224
5 1MTR HARDWOOD GARDEN EDGING JWP51		224
5 4MTR HARDWOOD GARDEN EDGING JWP54		224

GARDEN LIME

MULTICROP GARDEN LIME 3KG	MAX41220	5
-------------------------------------	----------	---

GYP SUM

GYP SUM 25KG	EEM02	1
--------------	-------	---

HESSIAN BAGS

 29" X 18" HESSIAN BAGS (50)	HSS7646	1
---	---------	---

HESSIAN TREE TIE

HESSIAN TREE TIE 50MM X 33MTR (36YARDS)	HSS5033	12
---	---------	----

HYDRANGEA

YATES HYDRANGEA FOOD BLUEING 500ML Y54749		6
HYDRANGEA FOOD PINK 500ML Y54750		6

INSECT TRAP

NON TOXIC STICKY TRAP FOR TRAPPING INSECTS - TUBE SHAPE

 INSECT TRAP HTC1		36
INSECT TRAP WITH CONTROL HTC1A		36

JOLLY TIES

 JOLLY GARDEN TIES 25MTR JT1		1
JOLLY TREE TIES NAVY 40MTR JT2		1

GARDEN PRODUCTS

Description	Product Code	Box Qty
-------------	--------------	---------

LAWN FERTILIZER**MUNNS**

GOLF COURSE GREEN ORGANIC 2 5KG (55238)	MGC25	1
GOLF COURSE GREEN ORGANIC 5KG (55239)	MGC5	1
GOLF COURSE GREEN ORGANIC 10KG (55237)	MGC10	1
GOLF COURSE GREEN ORGANIC 20KG (55236)	MGC20	1

**SCOTTS**

LAWN BUILDER 2 5KG (REGULAR)	SCOT1269	3
LAWN BUILDER 4KG ALL PURPOSE	SCOT1276	4
LAWN BUILDER 8KG ALL PURPOSE	SCOT0224	1
LAWN BUILDER & WEED KILL 2 5KG	SCOT1344	4
LAWN BUILDER & WEED KILL 4KG	SCOT1351	4
LAWN BUILDER FOR BUFFALO 4KG	SCOT108416	4

**LAWN GRUB KILLER****MUNNS**

LAWN GRUB KILLER 1KG BOTTLE	MLG1	6
-----------------------------	------	---

LAWN SEEDS**FAIRBANKS - BALMORAL HARDWEARING LAWN SEEDS**

"PERENNIAL RYE 36%, CREEPING RED /CHEW FESCUE 4%, KENTUCKY BLUE 12%, HIGHLAND BENT 48%"

BALMORAL HARDWEARING 5KG	SBAL5	1
--------------------------	-------	---

FAIRBANKS - SHADY MIX LAWN SEED

TALL FESCUE

DRY CLIMATE/TALL FESCUE 5KG	SDC5	1
-----------------------------	------	---

MUNNS

ARID SMARTGRASS 400G (COVERAGE 10 SQ M) (55201)	SARID400	10
ARID SMARTGRASS 1KG BOX (COVERAGE 25 SQ M) (55202)	SARID1	10
ARID SMARTGRASS 2 5KG BAG (COVERAGE 62 SQ M) (55203)	SARID2	6
BUDGET LAWN SEED 1KG (COVERAGE 50 SQ M) (55219)	MBUDGET1	10
BUDGET LAWN SEED 3KG (COVERAGE 150 SQ M) (55220)	MBUDGET3	5
EMERALD KIKUYU LAWN SEED MIX 400G (55230)	MEK400	10
EMERALD KIKUYU LAWN SEED MIX 1KG (55227)	MEK1	10
EMERALD KIKUYU LAWN SEED MIX 2 5KG (55229)	MEK25	6
FAST GRASS REPAIR BOX 2KG (COVERAGE UP TO 40 SQ M) (55233)	MFGLP2	5
GOLF COURSE GREEN ORGANIC BOX 500G (COVERAGE 20 SQ M) (55243)	MGCG500	10
PIXIE SUN 'N' SHADE 400G (COVERAGE 10 SQ M) (55260)	MPIXIE400	10



Description	Product Code	Box Qty
PIXIE SUN 'N' SHADE 1KG (COVERAGE 25 SQ M) (55259) MPIXIE1		5
POOCH COUCH 500G (COVERAGE 50 SQ M) (55258) PC		10
POOCH COUCH 1KG (55256) PC1		10
VALLEY SEED		
PERENNIAL RYE 44%, ANNUAL RYE 44%, BENT GRASS 0.3%, FESCUE 1.7% & NUTRICOTE FERTILIZER 10%		
FAIRBANKS/VALLEY SEED LANDSCAPE MIX 5KG SLM5		1
FAIRBANKS/VALLEY SEED LANDSCAPE MIX 25KG SLM25		1



LAWN STARTER

MUNNS

SUPERSTART LAWN STARTER FERTILISER 2 5KG (COVERAGE 25 SQ M) (55267) MLS25		1
SUPERSTART LAWN STARTER FERTILISER 5KG (COVERAGE 50 SQ M) (55269) MLS5		1
SUPERSTART LAWN STARTER FERTILISER 10KG (COVERAGE 100 SQ M) (55266) MLS10		1

LEAF CURL COPPER FUNGICIDE SPRAY

YATES

LEAF CURL SPRAY 250G	Y24905	12
----------------------	--------	----

LIME SULPHUR

LIME SULPHUR SPRAY 'F' 500ML	Y52554	6
------------------------------	--------	---

MANCOZEB PLUS

MANCOZEB PLUS POWDER 150G FUNGICIDE + MITICIDE	Y53850	6
--	--------	---

MANURE

NOT STOCKED ITEM - DIRECT DELIVERY ONLY - FULL PALLETS ONLY

COW MANURE ENPAC1		84
POULTRY MANURE ENPAC2		84
MIXED ANIMAL MANURE ENPAC3		84
PURE SHEEP MANURE 25LTR ENPAC4		84

* FREIGHT MAY APPLY TO CERTAIN AREAS

MARKER DYE

FOR WEEDSPRAY COLOURING

HERBICIDE MARKER DYE KENDON 'RED' 250ML	KA7204L	12
---	---------	----



GARDEN PRODUCTS

Description	Product Code	Box Qty
-------------	--------------	---------

MAVRIK

MAVRIK GUN 750ML Y52085		6
MAVRIK CONCENTRATE 200ML Y52557		6

NO GROW 500 GLYPHOSATE

500G/L GLYPHOSATE PRESENT AS ISOPROPYLAMINE SALT RAINFAST IN 2 HOURS WHEN SPRAYED ONTO SMALL YOUNG ACTIVELY GROWING WEEDS LESS THAN 6 WEEKS OLD.

NO GROW 500 GOLD 1LTR	CRG0100	6
-----------------------	---------	---

**ORCHID FOOD**

500ML THRIVE ORCHID LIQUID CONCENTRATE	Y54747	6
--	--------	---

ORCHID POTTING MIX

MAXICROP ORCHID POTTING MIX BRUNNINGS 25LTR	MAX31194	1
---	----------	---

PATHWEEDER

YATES ONCE A YEAR PATHWEEDER CONC 500ML Y54402		6
YATES ONCE A YEAR PATHWEEDER TRIGGER RTU 750ML Y54404		6

PEATMOSS

MAXICROP PEAT MOSS BRUNNINGS 5LTR	MAX31344	6
---	----------	---

PEST OIL

YATES PEST OIL CONCENTRATE 200ML Y42808		12
PEST OIL CONCENTRATE 500ML Y42806		12
PEST OIL R T U 750ML Y50736		6

PLANT STARTER

MAXICROP 1 LTR	MAX90410	6
--------------------------	----------	---

PYRETHRUM

HEINIGER PYRETHRUM SPRAY 200ML CRG0150		6
YATES 750ML PYRETHRUM INSECT SPRAY R T U (39306) Y50709		12
PYRETHRUM INSECTICIDE 200ML Y34035		6



Description	Product Code	Box Qty
RAT & MICE KILL - BAIT & TRAPS		
TOMCAT TOMCAT MOUSE BAIT STATION (CR)	SCOTBL33467	12
TOMCAT RODENT BAIT STATION (CR)	SCOTBL33475	5
TOMCAT MOUSE SNAP TRAP	SCOTBL33505	12
TOMCAT LIVE CATCH TRAP	SCOTBL33510	4
TOMCAT RAT SNAP TRAP	SCOTBL33525	8
TOMCAT MOUSE ATTRACTANT GEL 1OZ	SCOTBL33901	12
TOMCAT THROW PACKS (6PKT)	SCOTBL911013	12
TOMCAT PRE-PACK STATION (4 PACK)	SCOTBL913340	12
TOMCAT BLOX PACKET (8X28G)	SCOTBL913610	12
TOMCAT BLOX PAIL 784G	SCOTBL913619	6
YATES RATSACK DOUBLE STRENGTH 350G YATES	Y52331	6
RATSACK FAST ACTION (THROW AWAY PK) 5 X 20 100G	Y52330	6



ROOTEX		
18G POWDER	CRG2476	12



ROSE BLACK SPOT		
YATES ROSE SHIELD 200ML (55009) Y43623		6
ROSE SHIELD 500ML (55010) Y43872		6

ROSE GUN - INSECTICIDE		
YATES ROSE GUN ADVANCED RTU 750ML	Y51787	6

ROUNDUP		
ROUND UP GEL 150ML SCOT4216		6
ROUND UP RTU REGULAR 1LTR SCOT199870		6
ROUND UP RTU FAST ACTION (12HR) 1LTR SCOT199736		6

SAND AND SOIL BAGS		
SAND & SOIL BAGS 460W X 760H X 140UM (100) + U V SSB460140NA		1
SAND BAGS 460MM X 760 X 140MM (200 PER ROLL) SSB460140ROLL		1

SCALE GUN		
YATES SCALE GUN RTU 750ML	Y50735	6

GARDEN PRODUCTS

Description	Product Code	Box Qty
-------------	--------------	---------

SEED RAISING MIX

YATES

YATES SEED RAISING MIX 6LTR Y51422		4
YATES SEED RAISING MIX 15LTR Y51423		1

SNAIL AND SLUG

BAYER

BAYSOL SNAIL & SLUG 600G Y27507		12
BAYSOL SNAIL & SLUG 1KG Y13936		12

MAXICROP

MULTIGUARD SNAIL & SLUG KILLER 600G MAX94005		12
MULTIGUARD SNAIL & SLUG KILLER 2.5KG MAX94020		6
MULTIGUARD SNAIL & SLUG KILLER 1KG MAX94015		12

SCOTTS

DEFENDER SNAIL PELLETS 600G SCOT9029		12
DEFENDER SNAIL PELLETS 1KG SCOT0404		12

YATES

BLITZEM SNAIL PELLETS 500G Y52204		6
BLITZEM SNAIL PELLETS 1KG Y34388		12



SPRAYERS

FAIRBANKS SPRAYERS

TRIGGER SPRAYER 500ML	SPRAY500	1
TRIGGER SPRAYER 1LTR	SPRAY1	1
PRESSURE SPRAYER 1LTR (BRASS NOZZLE)	SPRAY1P	1
PRESSURE SPRAYER 2LTR (BRASS NOZZLE)	SPRAY2P	1
GARDEN SPRAYER 5LTR	SPRAY5	1
GARDEN SPRAYER 8LTR	SPRAY8	1
KNAPSACK SPRAY 15LTR VITON SEAL (BRASS NOZZLE)	SPRAY15	1

HILLS

HILLS TRIGGER SPRAYER 1 LITRE	BH100723	1
HILLS GARDEN SPRAYER 5L	BH100728	1
HILLS GARDEN SPRAYER 8LTR	BH100732	1
HILLS GARDEN INVERTOR 360 SPRAYER 1.5L	BH100738	1
HILLS TRIGGER SPRAYER 500ML	BH220063	1
HILLS 12LTR KNAPSACK SPRAYER	BH220490	1
HILLS PRESSURE SPRAYER 1 LITRE	BH404114	1
HILLS PRESSURE SPRAYER 2 LITRE	BH404122	1

Description	Product Code	Box Qty
SUCCESS ULTRA		
YATES SUCCESS ULTRA 200ML	Y54424	6
SUGAR CANE MULCH		
BALE COVERS APPROX 7 SQ MTRS AT 50MM THICK 200LT - BALE SIZE: 560MM X 380MM X 310MM		
MULCH SMART SUGAR CANE MULCH CMLA		42
MULCH SMART SUGAR CANE MULCH (FULL PALLETS) CMLA		42
SULPHATE OF AMMONIA		
MAXICROP SULPHATE OF AMMONIA 5KG	MAX42606	3
LIQUID POTASH		
YATES LIQUID POTASH 500ML	Y54745	6
TIMBER STAKES		
38MM SINGLE UNITS		
38 X 38 X 1200MM	TS381200	100
38 X 38 X 1500MM	TS381500	1
38 X 38 X 1800MM	TS381800	1
38 X 38 X 2100MM	TS382100	1
38 X 38 X 2400MM	TS382400	100
50MM SINGLE UNITS		
50 X 50 X 1200MM	TS501200	50
50 X 50 X 1500MM	TS501500	50
50 X 50 X 1800MM	TS501800	50
50 X 50 X 2100MM	TS502100	50
50 X 50 X 2400MM	TS502400	50
PACKS OF (10)		
25 X 25 X 300MM	TS25300	100
25 X 25 X 450MM	TS25450	100
25 X 25 X 600MM	TS25600	100
25 X 25 X 900MM	TS25900	1
25 X 25 X 1200MM	TS251200	1
25 X 25 X 1500MM	TS251500	1
25 X 25 X 1800MM	TS251800	1



GARDEN PRODUCTS

Description	Product Code	Box Qty
25 X 25 X 2100MM	TS252100	1
25 X 25 X 2400MM	TS252400	1
TREE AND BLACKBERRY KILLER		
TREE AND BLACKBERRY KILL 250ML	Y53849	6
TREE STAC		
300G TREE STAC	HTC4	12
TREE TIES		
ALL PURPOSE CHAINLOCK 10MM X 100MTR (PLASTIC)	MAX0288	1
VEGETABLE DUST		
YATES NATURE'S WAY VEGETABLE DUST 500G	Y51449	12
TOMATO + VEGETABLE DUST 500G	Y52862	12
WASP NEST DESTROYER		
WASP NEST DESTROYER 350G (AERO)	Y51433	6
WATERING CANS		
WATERING CAN 9LTR (CLEAR)	WC9	1
WEED AND FEED		
YATES WEED & FEED HOSE ON 2 4LTR (54247)	Y44595	4
WEED N FEED HOSE ON 4LTR (54248)	Y44594	3
WEED N FEED 12 5KG VALUE PK (GRANULAR)	Y51644	1
WEED KILLER		
BROADLEAF WEED CONTROL KAMBA M NUFARM 1LTR	NFK1	10
YATES BUFFALO PRO HOSE ON WEED KILLER 2 LTR	Y51690	4
BUFFALO PRO CONCENTRATE 250ML BIND + BROADLEAF WEEDER	Y52211	6
ECO SLASHER WEED KILLER 1LTR	Y55761	6
SLASHER WEED KILLER 750ML RTY	Y55759	6



Description	Product Code	Box Qty
-------------	--------------	---------

WEEDMASTER 360

GLYPHOSATE 360 CONCENTRATE.

1 LTR NF1		10
5 LTR NF5		1
20 LTR NF20		1

WEEDMATS (GROUND COVERS)

1 83MTR X 5MTR WOVEN WEEDMAT HANDY	WCM1805	1
1 83MTR X 10MTR WOVEN WEEDMAT HANDY	WCM1810	1

ACCESSORIES

WEEDMAT PINS GROUND STAPLES (20 PER PACK)	ACM3180A	1
HOT DIP GALV LANDSCAPE WEEDMAT PINS (200)	ACM315HDG	1

LYNX

UV STABILIZED - SUITABLE FOR ON GROUND USE

WEEDMAT 910MM X 25MTR	WCM0925	1
WEEDMAT 910MM X 50MTR	WCM0950	1
WEEDMAT 1 83MTR X 25MTR	WCM1825	1
WEEDMAT 1 83MTR X 50MTR	WCM1850A	1
WEEDMAT 915MM X 100M	WCM09100	1

MULCH MATE - LYNX

1830MM X 50MTR MULCH MATE	MM1850	1
---------------------------	--------	---

WETTING AGENTS**MUNNS**

WETA LAWN & GARDEN LONG LIFE BOX 2 5KG (COVERED 50SQM) MWLG25		1
WETA LAWN & GARDEN LONG LIFE REFILL 10KG(COVERED UP TO 200SQM) MWLG10R		1

WHITE OIL - INSECTICIDE

HEINIGER SUPERIOR WHITE OIL 200ML CRG0140		6
---	--	---

YATES

WHITE OIL INSECTICIDE 500ML Y34366		6
WHITE OIL AEROSOL YATES 400G Y52100		4



GARDEN PRODUCTS

Description	Product Code	Box Qty
-------------	--------------	---------

WOODEN PEGS**LANDSCAPING / CONCRETE PEGS**

50MM X 25MM (25 PER BUNDLE)

WOODEN PEGS 300MM 12" (PER 25) SP12		80
WOODEN PEGS 450MM 18" (PER 25) SP18		60
WOODEN PEGS 600MM 24" (PER 25) SP24		40
WOODEN PEGS 900MM 36" (PER 25) SP36		25

**ZERO WEEDSPRAY****WEED SPRAY**

ZERO READY TO USE WEED SPRAY BIG GUN 3LTR Y50406		3
ZERO GLYPHOSATE WEEDSPRAY RTU 750ML Y50739		6

GLYPHOSATE - CONCENTRATE 490

490G/L = GRAMS PER LITRE

ZERO GLYPHOSATE 490G/L WEEDSPRAY 200ML Y40972		6
ZERO GLYPHOSATE 490G/L WEEDSPRAY 500ML Y41002		6
ZERO GLYPHOSATE 490G/L WEEDSPRAY 1LTR Y41062		6



TOOLS

AXE	1
BARS	1
BLOCKSPLITTERS	1
BOLSTERS	1
BOLT CUTTERS	1
BRICK HAMMER	1
BROOM HANDLES	1
BROOMS	1
BROOMS WITH HANDLE AND STAY	1
BRUSHWARE	1
CEMENT EDGER	2
CLAW HAMMER	2
CULTIVATOR	2
DUST MASK	2
DUSTPAN SET	2
EAR MUFF	2
EAR PLUGS	2
FISKARS TOOLS	2
FORKS	3
HACKSAW	3
HANDLES	3
HANDBSAW	3
HEDGE SHEARS	3
HOE	3
KNIFE TRIMMING	3
LAWN LEVELLERS	3
LEVELS (SPIRIT LEVELS)	4
LOPPERS	4
MARKERS	4
MASH HAMMER	4
MATTOCKS	4
NIPPERS	4
PAINT BRUSHES	4
PAINT ROLLER	4
PENCILS - CARPENTERS	4
PLIERS	4
POST RAMMER	5
POST LIFTER	5
RAKES	5
RAKE HOE	5
RUBBER MALLETS	5
SAW	5
SEED AND FERTILIZER SPREADERS	5
SHOVELS	5
SLEDGE HAMMERS	6
SPONGES	6
STAPLES	6
STONE HAMMER	6
STRINGLINE	7
TAPE MEASURES	7
TIN SNIPS	7
TROWELS - BRICK & CONCRETE	7
WOODEN - FLOATS	7



Description	Product Code	Box Qty
-------------	--------------	---------

AXE

MEDALIST AXE 4LB F/GLASS HANDLE	A05614	1
---------------------------------	--------	---

BARS**CYCLONE**

FENCING BAR 1650MM X 25MM HEX	TR604188	1
FENCING BAR 1830MM X 25MM HEX	TR604225	1
FENCING BAR 1800MM X 30MM HEX	TR604256	1
CROW BAR 1830MM X 25MM HEX	TR604447	1

BLOCKSPLITTERS

LYNX BLOCKSPLITTER 6LB F/GLASS HANDLE 880MM	L4435	1
---	-------	---

BOLSTERS

BOLSTERS BRICKIES 112MM	B042010	1
-------------------------	---------	---

BOLT CUTTERS

BOLT CUTTER 600MM	TBC0600	1
BOLT CUTTER 900MM	TBC0900	1

BRICK HAMMER

BRICK HAMMER FIBREGLASS HANDLE 24OZ	A05599	1
-------------------------------------	--------	---

BROOM HANDLES

BROOM HANDLE 22MM X 1350MM	HB22	10
BROOM HANDLE 25MM X 1500MM	HB25	10

BROOM HEADS

BROOM HEAD (FOR CONCRETE SEALING)	GB141614	6
-----------------------------------	----------	---

BROOMS WITH HANDLE

CANE YARD BROOM HEAD & HANDLE	BR351C	1
450MM TROJAN BROOM (MEDIUM) PP & HANDLE	BR450M	1
600MM TROJAN BROOM (MEDIUM) PP & HANDLE	BR600M	1
600MM TIMBER BACK BROOM-ALL HAIR & HANDLE	BR610AH	1

BRUSHWARE

DAIRY SCRUB PLASTIC BACK NYLON	BR4480	1
--------------------------------	--------	---



Description	Product Code	Box Qty
CEMENT EDGER		
CEMENT EDGER 150MM	TGG0001	1
CLAW HAMMER		
CLAW HAMMER 20OZ	A05006	1
CULTIVATOR		
MEDALIST 3 PRONG FIBREGLASS HANDLE	A41667	1
DUST MASK		
DUST MASK NUISANCE 5PK SAFECORP	SCP1000	6
DUSTPAN SET		
TRADIES MATE MAXI DUSTPAN SET	BRTN-223540	1
EAR MUFFS		
EAR MUFF SWIVEL	SCP5015	1
FOLDABLE EAR MUFF YELLOW CLASS 5	STE500020	1
EAR PLUGS		
ULTRASAFE EAR PLUGS UNCORDED CLASS 5 (200 PAIRS)	STE500100	1
FOLDABLE EAR MUFF YELLOW CLASS 5	STE500200	1
FISKARS TOOLS		
FISKARS NYGLASS MULTI PURP SCOOP	FIS000267	12
FISKARS ALUMINIUM BYPASS PRUNER LARGE	FIS000991	8
FISKARS SOFTN GRIP BYPASS PRUNER MEDIUM	FIS001004	8
FISKARS BYPASS PRUNER	FIS001165	8
FISKARS NYGLASS TROWELL	FIS010291	12
FISKARS SINGLE STEP BYPASS PRUNER P26	FIS112606	8
FISKARS TELESCOPIC POWERLEVER LOPPER	FIS191689	6
FISKARS POWERGEAR BYPASS LOPPER L72	FIS122001	4
FISKARS NYGLASS TRANSPLANTER	FIS020290	12
FISKARS LARGE EURO PRUNER WITH HOLSTER	FIS024592	6
FISKARS NYGLASS CULTIVATOR	FIS030299	12
FISKARS CLASSIC TREE PRUNER	FIS131036	4
FISKARS NYGLASS WEEDER	FIS040298	12
FISKARS POWERGEAR BYPASS PRUNER LARGE	FIS965417	4



Description	Product Code	Box Qty
FISKARS SINGLE STEP HEDGE SHEAR HS22 FIS147301		4
FISKARS TELESCOPIC POWER HEDGE SHEAR FIS191696		6
FISKARS NYGLASS PLANTER HOE FIS000724		8
FISKARS GARDEN SCISSORS FIS196370		6
FISKARS BLOCKSPLITTER X27 2.7KG FIS225009		2
FISKARS MULSH FORK FIS002860		1
FISKARS SPLITTING AXE 2.5KG MODEL X25 FIS122483		1
FISKARS BOW SAW 21" FIS141004		1
FISKARS BOW SAW 24" SW31 FIS141011		1

FORKS

CYCLONE

10 TINE FORK MULCH/BARK TR630866		3
STEEL D SHAPED HANDLE 4 TINE WHITE 930MM AS55117		1

HACKSAW

HACKSAW SWEDISH PATTERN 300MM	TSD8300	1
-------------------------------	---------	---

HANSAW

HANSAW 550MM / 22" X 8PT EAGLE	S046560	1
--------------------------------	---------	---

HEDGE SHEARS

REFER TO FISKARS TOOL SECTION

HOE

LYNX HOE 47" HANDLE F/GLASS	L4442	1
-----------------------------	-------	---

KNIFE TRIMMING

SUPERCRAFT

SNAP OFF BLADE KNIFE COMPLETE 9MM TLC1001		20
KNIFE UTILITY METAL EK90822		6
KNIFE FLUO W RETRACTABLE BLADE (24) DISPLAY BOX K130000		1



Description	Product Code	Box Qty
-------------	--------------	---------

LAWN/SOIL LEVELLERS**CYCLONE**

LAWN LEVELLERS 710MM TIMBER HANDLE TR633621

2

LYNX

LAWN LEVELLER FIBREGLASS HANDLE L4374

1

LEVELS (SPIRIT LEVELS)**EAGLE**

LEVEL BOX 1200MM & COVER L038054

1

SUPERCRAFT

LEVEL BOX 1200MM ANNODISED TLS4010

1

LOPPERS

REFER TO FISKARS TOOL SECTION

MARKERS

BLACK INK MARKER 190 (12) DYMARK DYM12141201

1

BLACK INK MARKER FINE (10) DYMARK DYM1215001

1

MASH HAMMER

MASH HAMMER 2 5 POUND TIMBER HANDLE

TAJ0120

1

MATTOCKS

2KG MATTOCK CUTTER END WITH HANDLE TR634475

1

CUTTER END MATTOCK WITH FIBREGLASS HANDLE A44412

1

MATTOCK PICK WITH FIBREGLASS HANDLE A44419

1

NIPPERS

CONCRETORS NIPPERS

TC250CV

1

PAINT BRUSHES

PAINT BRUSHES 25MM A09401

12

PAINT BRUSHES 50MM A09403

12

PAINT BRUSHES 75MM A09405

12

PAINT BRUSHES 100MM A09406

12

PAINT ROLLER

PAINT ROLLER KIT SUPER CRAFT 230MM X 9MM

SPP1510

2

Description	Product Code	Box Qty
-------------	--------------	---------

PENCILS - CARPENTERS

SUPERCRAFT

PENCILS CARPENTERS MED S/CRAFT (1PKT OF 10) TCP0002		1
PENCILS CARPENTERS HARD S/CRAFT (1PKT OF 10) TCP0003		1

PLIERS

EAGLE MINI DIAGONAL CUTTING PLIER	P220042	2
-----------------------------------	---------	---



POST HOLE DIGGER - 2 HANDLES

LYNX POST HOLE DIGGER WITH FIBREGLASS HANDLES L4336		1
GARDEN MASTER POST HOLE PINCER (STEEL) A482220		1
CYCLONE POST HOLE PINCER WITH STEEL HANDLES A482110		1

POST LIFTER

STELLAR POST LIFTER PLIFTER		1
LYNX POST LIFTER GALVANISED PLIFTERGAL		1

RAKES

CYCLONE

RAKE LANDSCAPE 16T LH TR636554		3
GREAT AUSSIE RAKE ALUMINIUM TR636974		6

LYNX

RAKE GENERAL PURPOSE LYNX 16TH F/G HDL W/BRACE L4381		1
RAKE LANDSCAPER 16TH F/G HANDLE L4398		1



RAKHO

CYCLONE

RAKHO FIRE FIGHTING HOE	TR631849	2
-------------------------	----------	---

RUBBER MALLETS

RUBBER Mallet (WHITE) F/G HANDLE 32OZ L4312		1
RUBBER Mallet (BLACK) F/G HANDLE 32OZ L4329		1
900G RUBBER Mallet T/HANDLE S/C TAM0900		1
MEDALIST RUBBER Mallet F/G HANDLE 32OZ A04507		1



SAW

HAND SAW 550MM	S046560	6
----------------	---------	---

Description

Product
CodeBox
Qty

SEED AND FERTILIZER SPREADERS

SCOTTS

HANDY GREEN SPREADER SCOT71030

12

EASY GREEN SPREADER (BROADCAST SPREADER) SCOT01238

1

SHOVELS

CYCLONE

POST HOLE SQ MOUTH L/H SHOVEL (TIMBER HANDLE)

TR640001

3

TRENCHING L/H SHOVEL

TR640216

3

DEEP HOLE POST HOLE SHOVEL

TR639685

6

SHIFTING SQUARE MOUTH O SIZE L/H SHOVEL

TR642241

3

POWER TOOL POST HOLE FIBREGLASS HANDLE

TR640025

3

SHIFTING SQUARE MOUTH O SIZE GALVANISED D HANDLE SHOVEL

TR641763

3

GARDEN MASTER

SQ MTH POST HOLE L/H SHOVEL

TR640018

4

LYNX

ALL STEEL SHOVEL WHITE 930MM D HANDLE

ASS3018A

10

ALL STEEL SHOVEL ORANGE 1030MM D HANDLE

ASS3025A

10

ALL STEEL LONG HANDLE SHOVEL ORANGE 1500MM

ASS3032A

10

ALL STEEL SHOVEL 930MM D HANDLE PINK

ASS3018PINKA

10

ALL STEEL SHOVEL 1030MM D HANDLE BLUE

ASS3025BLUEA

10

ALL STEEL SHOVEL 1030MM D HANDLE WHITE

ASS3025WHITEA

10

ALL STEEL SHOVEL 1030MM D HANDLE GREEN

ASS3025GREENA

10

ALL STEEL SHOVEL 1030MM D HANDLE PURPLE

ASS3025PURPLEA

10

ALL STEEL SHOVEL 1030MM D HANDLE YELLOW

ASS3025YELLOWA

10

POST HOLE SHOVEL FIBREGLASS HANDLE

L4343

1

SQUARE MTH SHOVEL L/H FIBREGLASS HANDLE

L4350

1

SQUARE MTH SHOVEL FIBREGLASS D HANDLE

L4367

1

SLEDGE HAMMERS

LYNX

SLEDGE HAMMER 8LB FIBREGLASS HANDLE L4282

1

SLEDGE HAMMER 10LB FIBREGLASS HANDLE L4299

1

MEDALIST

SLEDGE HAMMER 4LB FIBREGLASS HANDLE A05603

1

SLEDGE HAMMER 10LB FIBREGLASS HANDLE A05610

1

SPONGES

BRICKIES FOAM SPONGES 200MM X 120MM X 75MM (28 PER BOX)

HC31190

1

Description	Product Code	Box Qty
-------------	--------------	---------

STAPLES**ARROW**

T50 STAPLES 1/4 6MM (1250PK)	MAR50424SP	1
T50 STAPLES 5/16 8MM (1250PK)	MAR50524SP	1
T50 STAPLES 3/8 10MM (1250PK)	MAR50624SP	1
T50 STAPLES 1/2 12MM (1250PK)	MAR50824SP	1

HAMMER TACKER

ARROW HAMMER TACKER	MARHT50IRED	1
---------------------	-------------	---

**STRINGLINE****FLURO PINK**

STRINGLINE PINK NO 8 X 50MTR (10 PER BOX) SLF850PINK		1
STRINGLINE PINK NO 8 X 100MTR (10 PER BOX) SLF8100PINK		1

**FLURO LIME**

STRINGLINE LIME NO 8 X 50MTR (10 PER BOX) SLF850LIME		1
STRINGLINE LIME NO 8 X 100MTR (10 PER BOX) SLF8100LIME		1
STRING LINE NO 12 X 100MTR (10 PER BOX) SLF12100		1
STRING LINE NO 12 X 50MTR (10 PER BOX) SLF1250		1

FLURO WHITE

STRINGLINE WHITE NO 8 X 100MTR (10 PER BOX) SL8100		1
STRINGLINE WHITE NO 8 X 50MTR (10 PER BOX) SL850		1

TAPE MEASURES

TAPE MEASURE FLURO 8MTR 26' (SMALL)	TRA8008	12
-------------------------------------	---------	----

**TIN SNIPS**

SNIPS AVIATION (STRAIGHT) SUPERCRAFT	TPG0030	1
--------------------------------------	---------	---

TROWELS - BRICK AND CONCRETE

TROWEL FLOOR POINTED 350MM SUPERCRAFT TGF0350		1
TROWEL GAUGING 150MM EAGLE T500040		1
TROWEL GAUGING 175MM SUPERCRAFT TGG0107		1
TROWEL GAUGING 200MM SUPERCRAFT TGG0108		1
TROWEL PLASTERERS 280MM SUPERCRAFT TGF0111		1
TROWEL POINTING 150MM SUPERCRAFT TGP0106		1
TROWEL POINTING 175MM SUPERCRAFT TGP0107		1
TROWEL PLASTS NOTCH 280MM SUPERCRAFT TGF1111		1
TROWEL BRICK 250MM SUPERCRAFT TGB0110		1



Description	Product Code	Box Qty
TROWEL BRICK 300MM SUPERCRAFT TGB0111		1
GROOVER CEMENT 150MM SUPERCRAFT TGC0000		1
EDGER CEMENT 150MM TGG0001		1

WIRE BRUSH

S/CRAFT WIRE BRUSH 4 ROW & SCRAPER	B214020	6
------------------------------------	---------	---

**WOODEN - FLOATS**

WOODEN PINE FLOAT 280MM X 110MM	T530080	1
---------------------------------	---------	---

WATERING SYSTEMS

HOSE - GARDENA	1
HOSE - OTHER BRAND	1
HOSE NOZZLE, GUN ETC	1
HOSE/TAP FITTINGS	1
HOSE/TAP FITTINGS - JOINER	1
POLYTUBE	2
SPRINKLERS	2
RAIN ACCESSORIES	2
UNDERGROUND WATERING SYSTEMS	
- SADDLE CLAMPS	2
- SHRUBBERS	2
- TEES	2

A large, stylized white letter 'G' is positioned in the bottom right corner of the page. The 'G' is thick and has a modern, slightly curved design. It is set against a solid red background that occupies the lower two-thirds of the page.

Description	Product Code	Box Qty
-------------	--------------	---------

HOSE - GARDENA

CONTACT OFFICE FOR PRICING

HOSE - OTHER BRAND

HOLMAN

SOAKER HOSE 15MTR	HOSEGH515F	10
-------------------------	------------	----

SUPREME HOSE

PREMIUM EXTENSION SUPREME HOSE 12MM X 18MTR	HOSEBH000047	1
---	--------------	---



HOSE NOZZLE, GUN ETC

HOLMANS

HOLMANS ADJUSTABLE PISTOL METAL	H2931H	6
---------------------------------------	--------	---

GARDENIA

ADJUSTABLE JET NOZZLE	NG18300-20	10
-----------------------------	------------	----

CLASSIC TRIGGER GUN NOZZLE	NG18301-20	10
----------------------------------	------------	----

GARDENA SOFT SPRAY GUN	NG18311-20	5
------------------------------	------------	---

HOSE/TAP FITTINGS

GARDERA

GARDENA TAP NUT ADAPTOR 12MM (18201-20)	NG901	24
---	-------	----

GARDENA TAP NUT ADAPTOR 18MM	NG18202-20	12
------------------------------------	------------	----

ADAPTOR 1/4" BSP	NG920	25
------------------------	-------	----

12MM TAP SUITS 18MM TAP ADAPTOR	NG924	20
---------------------------------------	-------	----

18MM TAP NYLEX TAP ADAPTOR	NG930	20
----------------------------------	-------	----

MULTIFLOW ADAPTOR (12 & 18MM TAPS)	NG1192/4	1
--	----------	---

FOUR CHANNEL WATER DISTRIBUTOR	NG8194	2
--------------------------------------	--------	---

12MM HOSE CONNECTOR STOP VALVE (18213-20)	NG913	24
---	-------	----

12MM HOSE CONNECTOR TAIL (18215-20)	NG915	24
---	-------	----

18MM HOSE CONNECTOR TAIL	NG916	20
--------------------------------	-------	----

HOSE COUPLING 12MM	NG931	20
--------------------------	-------	----

GARDENA TWIN TOP CONNECTOR	NG8193	4
----------------------------------	--------	---

HOSE JOINER-REPAIR 12MM (18232-20)	NG932	24
--	-------	----

HOSE JOINER-REPAIR 18MM (18233-20)	NG933	20
--	-------	----



Description	Product Code	Box Qty
POLYTUBE		
POLYTUBE 13MM X 25MTR	PT1325	5
POLYTUBE 13MM X 50MTR	PT1350	1
POLYTUBE 19MM X 25MTR	PT1925	5
POLYTUBE 19MM X 50MTR	PT1950	2
DRIP LINE		
13 X 50M DRIPLINE 2LTR/HR	HPD1350	1



SPRINKLERS		
3 ARM ROTARY SPRINKLER HOLMANS.....	SPRINKLER7445H	6
METAL DOME SPRINKLER WITH ADAPT	SPRINKLERSH2200	10



RAIN ACCESSORIES		
SIGN		
SIGN READING: RECYCLED WATER IN USE ON THIS PROPERTY . 300MM X 200MM X 3MM BLACK/WHITE	SIGN1	5



WATER DIVERTERS		
RAIN WATER DIVERTER 90MM	HRRRAINTAP	1

UNDERGROUND WATERING SYSTEMS - SADDLE CLAMPS		
SADDLE CLAMP 4MM WITH NAIL	HOLHMBS4N	25
SADDLE CLAMP 13MM WITH NAIL.....	HOLHMBS13N	25

UNDERGROUND WATERING SYSTEMS - SHRUBBERS		
SHRUBBER 360 DEGREE ADJ BARBED	HOL31445	100

UNDERGROUND WATERING SYSTEMS - TEES		
TEE REDUCING 19MM X 13MM.....	HOLHMBT1913	25
BARBED TEE 4MM.....	HOLHMBT4	25

WHEELBARROWS

WHEELBARROWS WITH STEEL TRAY	1
WHEELBARROWS WITH PLASTIC TRAY	2
LIGHT DUTY WHEELBARROWS IN KNOCK-DOWN KIT	3
NO FLAT TYRES	4
FLAT FREE TYRES FITTED ON RIM	5
LIGHT DUTY WHEELBARROWS - BOLTED	5
PUMA BARROWS - POLY & STEEL TRAY	5
SPARE PARTS FOR PUMA BARROWS	5
SPARE PARTS FOR LIGHT DUTY BOLTED LEGS	6
TYRE TUBES	6



WHEELBARROW WITH STEEL TRAY



FRAME:

- Heavy Duty 32mm Powder Coated Steel Tube and 25mm Front Tray Struts
- Welded Frame to Increase Strength
- Heavy Duty Front Wheel Guard
- Front Tray Support for Strength

HANDLES:

- Galvanised Steel Tube Handles - 30 x 60
- Quality Grips "UV Stabilised"

BEARINGS:

- Sealed to Ensure Long-Lasting
- Designed with "No-Slack" to give a firm, secure feel when lifting heavy loads

AXLE:

- SOLID STEEL - 25mm nom. diameter

WHEEL: (Heavy Duty Plastic Rim)

- 400 x 8 Tyre - 4 Ply (Normal) [WBP600S](#)
- 650 x 8 Tyre - 4 Ply (Wide Wheel) [WBP600SWW](#)

TRAY:

- Steel Tray - 6 cubic foot
(No bolt penetration into base of tray)

WEDGES:

- Designed to POSITION load

SHOCK BOARD:

- Heavy Duty Support Board

NOTE: Solid Foam Wheel available in 400 x 8 Tyre at an extra cost.

WHEELBARROW WITH PLASTIC TRAY

**FRAME:**

- Heavy Duty 32mm Powder Coated Steel Tube and 25mm Front Tray Struts
- Welded Frame to Increase Strength
- Heavy Duty Front Wheel Guard
- Front Tray Support for Strength

HANDLES:

- Galvanised Steel Tube Handles - 30 x 60
- Quality Grips "UV Stabilised"

BEARINGS:

- Sealed to Ensure Long-Lasting
- Designed with "No-Slack" to give a firm, secure feel when lifting heavy loads

AXLE:

- SOLID STEEL - 25mm nom. diameter

WHEEL: (Heavy Duty Plastic Rim)

- 400 x 8 Tyre - 4 Ply (Normal) [WBP600P](#)
- 650 x 8 Tyre - 4 Ply (Wide Wheel) [WBP600PWW](#)

TRAY:

- Plastic Tray - 6 cubic foot (UV Stabilised)

WEDGES:

- Designed to POSITION load

SHOCK BOARD:

- Heavy Duty Support Board

NOTE: Solid Foam Wheel available in 400 x 8 Tyre at an extra cost.



WHEELBARROWS LIGHT DUTY WHEELBARROW IN KNOCK-DOWN KIT



WB8612CKD

AXLE:

- Hollow Axle

TRAY:

- Plastic Tray - 6 cubic foot
- Steel Tray Bolted - [WB8612SBLACK](#)

FRAME:

- Bolted Tubular Steel Frame

HANDLES:

- Galvanised Steel Tube Handles
25 x 50

WHEEL:

- 400 x 8 Tyre (Normal) [WB8612CKD](#)
- 650 x 8 Tyre (Wide Wheel) [WB8612CWVKD](#)

NOTE: Assembly of this wheelbarrow is available at an extra cost.

NO FLAT TYRES

WHEELBARROWS



WBP600SFT
WBP600SWWFT
WBP600SWWFTKD

Professional Steel Tray Puma Barrow with NO FLAT TYRE

BARROW INFORMATION:

- TRAY: Steel Tray – 6 Cubic Foot
- WHEEL: Normal Wheel / Wide Wheel
 (*also available in Knock-Down Kit
 WBP600SWWFTKD)
- FRAME: Welded Tube Frame
- AXLE: Solid Steel – 25mm, nom. diameter
- HANDLES: Galvanised Steel Tube Handles 30 x 60

*Includes Shockboard (*Heavy Duty Support Board*)



WBP600PFT
WBP600PWWFT
WBP600PWWFTKD

Professional Poly Tray Puma Barrow with NO FLAT TYRE

BARROW INFORMATION:

- TRAY: Plastic Tray – 6 Cubic Foot
- WHEEL: Normal Wheel / Wide Wheel
 (*also available in Knock-Down Kit
 WBP600PWWFTKD)
- FRAME: Welded Tube Frame
- AXLE: Solid Steel – 25mm, nom. diameter
- HANDLES: Galvanised Steel Tube Handles 30 x 60

*Includes Shockboard (*Heavy Duty Support Board*)



Description	Product Code	Box Qty
-------------	--------------	---------

FLAT FREE TYRES FITTED ON RIM

4.00 - 8A FLAT FREE TYRE COMPLETE WITH RIM 400MM X 100MM.....	0WBFT	1
400MM X 150MM STEEL RIM WHEELBARROW WIDE WHEEL FLAT FREE TYRE	0WBFTWW	1



LIGHT DUTY WHEELBARROWS - BOLTED

LIGHT DUTY BARROW POLY TRAY NORMAL WHEEL (ASSEMBLED)	WBB8612C	1
LIGHT DUTY BARROW POLY TRAY WIDE WHEEL (ASSEMBLED)	WBB8612CWW	1
LIGHT DUTY BARROW POLY TRAY NORMAL WHEEL (KIT)	WBB8612CKD	1
LIGHT DUTY BARROW POLY TRAY WIDE WHEEL (KIT)	WBB8612WWKD	1

PUMA BARROWS

STEEL TRAY

WHEELBARROW WITH STEEL TRAY 4.00 - 8 STANDARD WHEEL	WBP600S	1
WHEELBARROW WITH STEEL TRAY 6.50 - 8 WIDE WHEEL	WBP600SWW	1

POLY TRAY

WHEELBARROW WITH POLY TRAY 4.00 - 8 STANDARD WHEEL	WBP600P	1
WHEELBARROW WITH POLY TRAY 6.50 - 8 WIDE WHEEL.....	WBP600PWW	1

POLY TRAY WITH FLAT FREE TYRE

WHEELBARROW POLY TRAY WITH FLAT FREE TYRE 4.00 - 8 STANDARD WHEEL	WBP600PFT	1
WHEELBARROW POLY TRAY WITH FLAT FREE TYRE 6.50 - 8 WIDE WHEEL	WBP600PWWFT	1
WHEELBARROW POLY TRAY WITH FLAT FREE TYRE 6.50 - 8 WIDE WHEEL (KIT)	WBP600SWWFTKD	1

STEEL TRAY

WHEELBARROW STEEL TRAY WITH FLAT FREE TYRE 4.00 - 8 STANDARD WHEEL	WBP600SFT	1
WHEELBARROW STEEL TRAY WITH FLAT FREE TYRE 6.50 - 8 WIDE WHEEL.	WBP600SWWFT	1
WHEELBARROW STEEL TRAY WITH FLAT FREE TYRE 6.50 - 8 WIDE WHEEL (KIT)	WBP600SWWFTKD	1

SPARE PARTS FOR PUMA BARROWS

FOR BOTH POLY AND STEEL TRAYS

PUMA STEEL TRAY BLUE.....	0WBPO1	1
PUMA POLY TRAY BLACK	0WBPO1POLY	1
PUMA PLASTIC SHOCK BOARD	0WBPO2	1
PUMA WEDGES (PAIR)	0WBPO3	1
PUMA HANDLES RED GRIP (PAIR).....	0WBPO4	1
PUMA AXLE BRACKETS (PAIR) RED - ONLY SUITS PUMA WHEEL	0WBPO6	1
PUMA WHEEL 4.00 - 8 (5 SPOKE) NORMAL WHEEL - ONLY SUITS PUMA AXLE	0WBPO7	1



Description	Product Code	Box Qty
PUMA WHEEL 6.50 - 8 (5 SPOKE) WIDE WHEEL - ONLY SUITS PUMA AXLE	0WBP07WW	1
PUMA AXLE SOLID - ONLY SUITS PUMA WHEEL	0WBP08	1
PUMA NOSE GUARD RED	0WBP9	1
PUMA T/BRACE RED 370MM (PAIR) S/TRAY	0WBP10	1
PUMA T/BRACE RED 435MM (PAIR) P/TRAY.	0WBP10A	1
PUMA CROSSING BAR BENT S/TRAY.	0WBP11	1
PUMA CROSSING BAR STRAIGHT P/TRAY	0WBP11A	1
PUMA BOLT AND NUT SET	0WBP12 13	1
PUMA TRANSFER 305 X 55 SINGLE	0WBP14	1
PUMA TRANSFER 305 X 100 PAIR.	0WBP15	1
PUMA TRANSFER 100 X 50 PAIR	0WBP16	1
PUMA TRANSFER 200 X 160 SINGLE	0WBP17	1
WASHER FLAT GALV 24MGW (EACH)	0WBP18	1

SPARE PARTS FOR LIGHT DUTY BOLTED LEGS

POLY TRAY BLACK	0WB8612C 1	1
BOLT AND NUT SET	0WB8612C 10	1
SHOCKBOARD	0WB8612C 2	1
HANDLES BLACK GRIP (PAIRS).	0WB8612C 3	1
RED BOLT LEG KIT	0WB8612C 4	1
RED AXLE BRACKET (PAIRS)	0WB8612C 5	1
WHEELS TURBINE 4.00 - 8 NORMAL WHEEL	0WB8612C 6	1
WHEELS TURBINE 6.50 - 8 WIDE WHEEL	0WB8612C 6WW	1
AXLE HOLLOW	0WB8612C 7	1
NOSE GUARD WITH HOLDER RED	0WB8612C 8	1
TRAY BRACE RED	0WB8612C 9	1

TYRE TUBES

TYRE TUBES FOR BARROWS

TYRE TUBE FOR LIGHT DUTY 4.00 - 8	0WBTT1	1
TYRE TUBE FOR LIGHT DUTY 6.50 - 8	0WBTT2	1

